

# Fittings Industrial

*Ratermann Manufacturing, Inc. carries a wide range of industrial fittings to meet your company needs.*

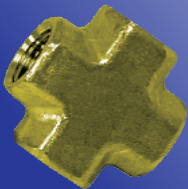
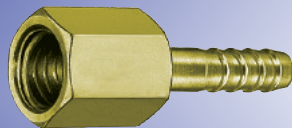
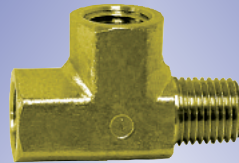
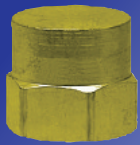

## INDEX

### *Industrial Fittings*

- Stainless Steel Counter Sunk Nipples, Regulator Nipples and Nuts ..... **13B-18**
- Handtight Manifold Assembly Parts ..... **13B-22**
- Brass and Copper Pigtail Assemblies ..... **13B-26**
- Brass Pipe Thread Fittings . . . . **13B-9**
- Power Cable Nipples and Connector Assemblies . . . . . **13B-13**
- Flash Arrestors and Quick Connectors ..... **13B-4**
- Brass Hose Ferrules, Braces and Clamps ..... **13B-7**
- Hose Repair Kit ..... **13B-8**

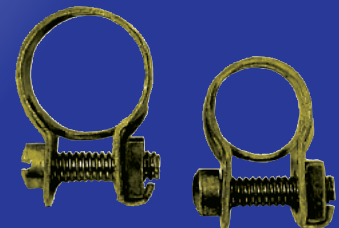

# Fast Delivery of the Products You Need!



## RATERMANN MFG. SIZE COMPARISONS CHART

### Actual Outside Diameters of Pipe Threads NPT

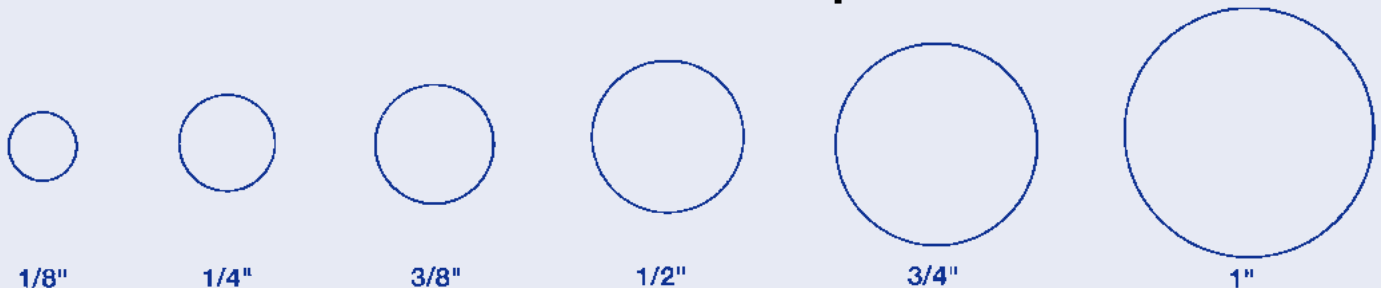

### Male Thread Profiles for NPT Threads Outside Diameter



# INDEX FOR FITTINGS INDUSTRIAL

## FOR TOP END LIQUID CYLINDER COMPONENTS

### ADAPTOR

Argon & Inert Arc.....13B-11, 12, 13  
Cylinder to Regulator,  
CGA .....13B-31, 32  
Hose-Oxygen & Acetylene –  
“A”, “B”, “C” &  
“D” Sizes .....13B-5, 6  
Manifold Pipeline  
Outlet, CGA.....13B-28, 33  
Pipe Thread.....13B-9, 10

### ASSEMBLIES

Brass and Copper Pigtail .....13B-27

### BUSHINGS

Outlet, Regulator – “A”,  
“B”, “C” & “D” Sizes.....13B-3, 10  
Pipe Thread.....13B-9  
Manifold Union Bushings.....13B-33

### BRITISH STYLE FITTINGS

All.....13B-13

### CABLE CONNECTORS

Nipples .....13B-12, 13

### CAPS

Dust Cap & Chain –  
CGA & Hose.....13B-24

### CHECK VALVES

Inline.....13B-3  
Manifold Pipeline  
Outlet, CGA.....13B-21, 33  
Nipple Type.....13B-21  
Torch, Regulator .....13B-3  
Tee, CGA.....13B-20, 21

### CLAMPS

Hose.....13B-7

### COUPLERS

Hose-Argon & Inert Arc ..13B-11, 12  
“A”, “B” & “C” Sizes.....13B-3  
Tees for Manifold, CGA...13B-20, 21

### FERRULES

Hose.....13B-7

### FILL PLANT LEADS

Rigid Stainless Steel .....13B-27

### FLASH ARRESTORS

Regulator & Torch .....13B-4

### FILTERS

Regulator Inlet .....13B-19

### HAND TIGHT

### ASSEMBLY PARTS

Nipples .....13B-22  
Nuts – Brass & Plastic .....13B-22

### INERT ARC FITTINGS

Adaptors.....13B-11, 12  
Couplers .....13B-11, 12  
Nipples .....13B-11, 12  
Nuts .....13B-11, 12  
Power Cable.....13B-12

### KITS

Hose Repair.....13B-8

### MANIFOLD

Fittings.....13B-35, 36  
Pipe Lengths .....13B-35  
Tees.....13B-19, 20

### NIPPLES

Hose – Inert Gas.....13B-11, 12, 13  
Hose - “A”, “B”, “C” &  
“D” Sizes.....13B-2, 3  
Manifold, Countersunk,  
Brass & Stainless .....13B-17, 18  
Regulator Inlet, CGA –  
Brass, Stainless &  
Chrome .....13B-17, 18  
Regulator Inlet, “A”, “B”, “C”  
& “D” Hose .....13B-2  
Union Nipples – Manifold.....13B-33

### NUTS

Adaptor – Regulator End, CGA –  
Brass & Chrome .....13B-29, 30  
Adaptor – Regulator End, CGA –  
Stainless .....13B-19  
Hand Tight.....13B-22  
Hose – Argon & Inert Gas.....13B-11  
Hose – Oxygen & Fuel Gas –  
“A”, “B”, “C” & “D” Sizes...13B-2  
Manifold .....13B-33  
Regulator Inlet, CGA –  
Brass.....13B-14, 15, 16

Regulator Inlet, CGA –

Stainless.....13B-18

### PIGTAIL ASSEMBLIES

Brass & Copper .....13B-26, 27  
Stainless Steel, Rigid .....13B-20

### PIPE THREAD FITTINGS

Brass & Stainless Steel.....13B-9, 10  
Hose.....13B-5

### PLUGS

Plug & Chain, CGA & Hose ..13B-25

### PROPANE TORCH

Superfire Air/Propane  
Torch.....13B-26

### QUICK CONNECTORS

Regulator & Torch .....13B-4

### SPLICERS

Hose.....13B-2

### TEES

Manifold, CGA –  
Brass & Stainless .....13B-20, 21  
Manifold, Pipe.....13B-34  
Pipe Thread –  
Brass & Stainless .....13B-9, 10

### TOOLS

Ferrule Crimping, Hand .....13B-8

### TUBING

Brass .....13B-26  
Copper .....13B-26  
Stainless Steel .....13B-26

### VALVES

Ball Seat Shut-Off.....13B-24  
“Y” with Valves .....13B-23

### WASHERS

All .....13B-14, 15, 16, 18, 19, 22

### “Y” CONNECTORS

“B” size –  
Oxygen & Fuel Gas .....13B-23  
Inert Gas.....13B-23  
Pipe Thread.....13B-23

# BRASS HOSE FITTINGS MAXIMUM PRESSURE 200 PSIG

## HOSE NUTS

Oxygen



Part No.	Std. Pkg.	Western Equivalent Part No.	Size	Internal Thread
N-10	50	9	Oxygen Aircraft "A"	3/8"-24-RH
N-11	50	10	Fuel Gas Aircraft "A"	3/8"-24-LH
N-20	100	7	Oxygen Standard "B"	9/16"-18-RH
N-21	100	8	Fuel Gas Standard "B"	9/16"-18-LH

Acetylene



Part No.	Std. Pkg.	Western Equivalent Part No.	Size	Internal Thread
N-30	50	RR-7	Oxygen Railroad	41/64"-18-RH
N-31	50	RR-8	Fuel Gas Railroad	41/64"-18-LH
N-34	25	C-7	Oxygen "C"	7/8"-14-RH
N-35	25	C-8	Fuel Gas "C"	7/8"-14-LH
N-42	10	D-7	Oxygen "D"	1-1/4"-12-RH
N-43	10	D-8	Fuel Gas "D"	1-1/4"-12-LH

## HOSE NIPPLES

Barb Hose Nipples



Part No.	Std. Pkg.	Western Equivalent Part No.	Size	Internal Thread
NP-4	50	19	Aircraft "A" 1 1/2" Long	3/16" I.D.
NP-5	50	-	Standard "B" 3 1/2" Long	1/8"-5/32" I.D.
NP-6	100	18	Standard "B" 1 1/2" Long	3/16" I.D.
NP-10	100	17	Standard "B" 1 1/2" Long	1/4" I.D.
NP-10W	100	17-W	Standard "B" With "O" Ring	1/4" I.D.
NP-12	25	C-19	Standard "C" 1 3/4" Long	1/4" I.D.
NP-14	50	216	Standard "B" 1 1/2" Long	5/16" I.D.
NP-18	50	20	Standard "B" 1 1/2" Long	3/8" I.D.
NP-20	50	20-A	Standard "B" 1 1/4" Long	3/8" I.D.
NP-24	25	C-20	Standard "C" 2" Long	3/8" I.D.
NP-28	25	C-18	Standard "C" 2 1/4" Long	1/2" I.D.
NP-30	25	C-17	Standard "C" 4 1/2" Long	1/2" I.D.
NP-34	10	D-17	Standard "D" 2 1/2" Long	1/2" I.D.
NP-36	10	D-18	Standard "D" 3 1/2" Long	3/4" I.D.
XOR-002	25	-	Buna-N replacement "O" rings for: NP-10W	

Spiral Hose Nipples



Part No.	Std. Pkg.	Western Equivalent Part No.	Size	Hose Size
NP-40	50	13	Aircraft "A"	3/16" I.D.
NP-42	100	12	Standard "B"	3/16" I.D.
NP-46	100	11	Standard "B"	1/4" I.D.
NP-54	50	138	Standard "B"	3/8" I.D.

Nipples With Threads  
"B", "C" & "D" Size



Part No.	Std. Pkg.	Western Equivalent Part No.	Size	Length
*NP-595	50	22	1/8" NPT "B"	1"
*NP-596	50	23	1/8" NPT "B"	1-1/2"
**NP-605	25	C-88	1/4" NPT "C"	2"
**NP-606	25	-	1/4" NPT "C"	2-1/2"
NP-640	10	D-20	1/2" NPT "D"	2-1/2"

\*Broached for Allen Wrench \*\* To order with filter, add Suffix "RF6"

## HOSE SPLICERS

Barb Hexagon Center Stop



Part No.	Std. Pkg.	Western Equivalent Part No.	Hose I.D.
S-233	50	38	3/16" to 3/16"
S-244	50	37	1/4" to 1/4"
S-255	50	139	5/16" to 5/16"
S-266	50	149	3/8" to 3/8"

Barb Round Center Stop



Part No.	Std. Pkg.	Western Equivalent Part No.	Hose I.D.
S-333	50	45	3/16" to 3/16"
S-344	50	44	1/4" to 1/4"
S-355	50	46	5/16" to 5/16"
S-366	50	47	3/8" to 3/8"
S-388	50	48	1/2" to 1/2"

Barb No Center Stop



Part No.	Std. Pkg.	Western Equivalent Part No.	Hose I.D.
S-433	50	55	3/16" to 3/16"
S-444	50	54	1/4" to 1/4"
S-466	50	57	3/8" to 3/8"

Spiral Hexagon Center Stop



Part No.	Std. Pkg.	Western Equivalent Part No.	Hose I.D.
S-533	50	35	3/16" to 3/16"
S-544	50	34	1/4" to 1/4"

# BRASS HOSE FITTINGS REGULATOR OUTLETS, CHECK VALVES

## HOSE COUPLERS REVERSE CHECK VALVES



Part No.	Std. Pkg.	Western Equivalent Part No.	Description External Thread Both Ends
C-10	25	130	Oxy. RH 3/8"-24 to 3/8"-24 "A" to "A"
C-11	25	131	Fuel Gas LH 3/8"-24 to 3/8"-24 "A" to "A"
C-20	25	230	Oxy. RH 9/16"-18 to 3/8"-24 "B" to "A"
C-21	25	231	Fuel Gas LH 9/16"-18 to 3/8"-24 "B" to "A"
C-50	50	30	Oxy. RH 9/16"-18 to 9/16"-18 "B" to "B"
C-51	50	31	Fuel Gas LH 9/16"-18 to 9/16"-18 "B" to "B"
C-80	10	C-30	Oxy. RH 7/8"-14 to 7/8"-14 "C" to "C"
C-81	10	C-31	Fuel Gas LH 7/8"-14 to 7/8"-14 "C" to "C"

### REGULATOR OUTLET BUSHINGS

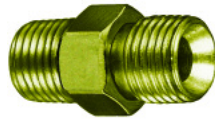

Part No.	Std. Pkg.	Western Equivalent Part No.	Male Pipe Thread To "A", "B", "C" Size External Thread
B-6	25	132	1/8" NPT to 3/8"-24-RH Oxygen "A" Size
B-7	25	133	1/8" NPT to 3/8"-24-LH Fuel Gas "A" Size
B-8	25	136	1/8" NPT to 9/16"-18-RH Oxygen "B" Size
B-9	25	137	1/8" NPT to 9/16"-18-LH Fuel Gas "B" Size
B-26	50	134	1/4" NPT to 3/8"-24-RH Oxygen "A" Size
B-27	50	135	1/4" NPT to 3/8"-24-LH Fuel Gas "A" Size
B-28	50	32	1/4" NPT to 9/16"-18-RH Oxygen "B" Size
B-28SS	50	SS-32	1/4" NPT to 9/16"-18-RH-EXT. Stainless Steel
B-29	50	33	1/4" NPT to 9/16"-18-LH Fuel Gas "B" Size
B-66	10	C-32	1/2" NPT to 7/8"-14-RH Oxygen "C" Size
B-67	10	C-33	1/2" NPT to 7/8"-14-LH Fuel Gas "C" Size

### LOW PRESSURE INLINE CHECK VALVES 200 PSI



Part No.	Std. Pkg.	Western Equivalent Part No.	Inlet	Flow	Outlet
CV-24	10	—	1/4" NPT Male	→	1/4" NPT Male
CV-25	10	—	1/4" NPT Male	→	1/4" NPT Female
CV-26	10	—	1/4" NPT Female	→	1/4" NPT Male

### "A" SIZE TORCH TYPE CHECK VALVE



Part No.	Western Equivalent Part No.	Attaches to Standard "A" Size Torch Inlet
CV-10R	CV-A-9	"A" Size Oxygen 3/8"-24-Ext. RH to "A" Size Oxygen 3/8"-24-Int. RH
CV-11L	CV-A-10	"A" Size Fuel Gas 3/8"-24-Ext. LH to "A" Size Fuel Gas 3/8"-24-Int. LH

Designed to prevent mixed gases in hoses and regulators

### "B" SIZE ONE PIECE TORCH TYPE 200 PSI MAXIMUM WORKING PRESSURE

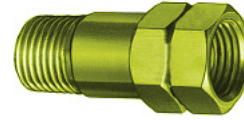

STD. PKG. 10

Part No.	Western Equivalent Part No.	Attach to Standard Torch Inlets with "B" Size Internal Nut & Nipple
CV-20R	CV-7R	"B" Size Oxy. 9/16"-18-RH-Ext. to 9/16"-18-RH-Int.
CV-21L	CV-8L	"B" Size Fuel Gas 9/16"-18-LH-Ext. to 9/16"-18-LH-Int.

### REGULATOR BUSHING ADAPTOR TYPE



STD. PKG. 10

Part No.	Western Equivalent Part No.	Attach to Std. "B" Size Regulator Outlet Bushing with "B" Size Internal Nut and Nipple
CV-128R	CV-30R	Oxygen 9/16"-RH-Int. to 9/16"-RH-Ext. "B"
CV-129L	CV-31R	Fuel Gas 9/16"-LH-Int. to 9/16"-LH-Int. "B"

### REGULATOR BUSHING ADAPTOR TYPE



Part No.	Western Equivalent Part No.	Replaces Std. "B" Size Regulator Outlet Bushing
CV-28R	CV-32R	Oxygen 1/4"-NPT-Ext. to 9/16"-18-RH-Ext. "B"
CV-29L	CV-33L	Fuel Gas 1/4"-NPT-Ext. to 9/16"-18-LH-Int. "B"

### HIGH PRESSURE INLINE CHECK VALVES

3,000 P.S.I.G.



Ratermann Part No.	Std. Pkg.	Inlet	Flow	Outlet
PIT-CVM14M14	10	1/4" NPT Male	→	1/4" NPT Male
PIT-CVF-14M14-RV	10	1/4" NPT Male	→	1/4" NPT Female
PIT-CVF-F14F14	10	1/4" NPT Female	→	1/4" NPT Female
PIT-CVF-M14M14	10	1/4" NPT Female	→	1/4" NPT Male

### HIGH PRESSURE INLINE CHECK VALVES

6,000 P.S.I.G.



Part No.	Std. Pkg.	Western Equivalent Part No.	Inlet	Flow	Outlet
CV-215SS	1	—	1/4" NPT Male	→	1/4" NPT Male
CV-219SS	1	—	1/4" NPT Male	→	1/4" NPT Female
CV-229SS	1	—	1/4" NPT Female	→	1/4" NPT Female
CV-230SS	1	CVF-4MSS	1/4" NPT Female	→	1/4" NPT Male

# FLASH ARRESTORS & QUICK CONNECTORS



- *Designed for “B” size torch & hose fittings*
- *Built in check valve prevents reverse flow of gases*
- *Stainless steel sintered element stops multiple flashes (no resetting required)*
- *U/L listed*
- *Purchase as POP display pack or as individual components*
- *High flow capacity*

Part No.	Western Equivalent	
	Part No.	Description
FBK-100	FA-30	Oxygen/Fuel Gas Set, Regulator Style, POP Display
FBK-200	FA-10	Oxygen/Fuel Gas Set, Torch Style, POP Display
FB-122	FA-130P	Individual Oxygen arrestor, Regulator Style
FB-123	FA-230P	Individual Fuel Gas arrestor, Regulator Style
FB-222	FA-100P	Individual Oxygen arrestor, Torch Style
FB-223	FA-200P	Individual Fuel Gas arrestor, Torch Style



- *Durable stainless steel coupling pin*
- *Designed for “B” size torch & hose fittings*
- *Meets strict ISO 7289 safety standards*
- *Non-interchangeable oxygen/fuel gas connectors prevent cross connections*
- *Built in automatic gas cut off shuts down gases when disconnected*

Part No.	Western Equivalent	
	Part No.	Description
QCT-100	QDB10	Oxygen/Fuel Gas Set, Torch Style, POP Display
QCR-200	QDB30	Oxygen/Fuel Gas Set, Regulator Style, POP Display
QCT-122	—	Individual Oxygen Connector, Regulator Style
QCT-123	—	Individual Fuel Gas Connector, Regulator Style
QCR-222	—	Individual Oxygen Connector, Torch Style
QCR-223	—	Individual Fuel Gas Connector, Torch Style
QCT-112-PIN	—	Male Pin Only Oxygen, Torch Style
QCT-113-PIN	QDB200	Male Pin Only Fuel Gas, Torch Style
QCT-222-PIN	QDB105	Male Pin Only Oxygen, Regulator Style
QCT-223-PIN	QDB205	Male Pin Only Fuel Gas, Regulator Style

# BRASS HOSE FITTINGS MAXIMUM PRESSURE 200 PSIG

## PIPE THREAD TO BARBED HOSE ADAPTOR



Part No.	Std. Pkg.	Western Equivalent Part No.	Male Pipe Thread	Barb Hose Size
A-101	25	548	1/8" NPT	1/8" I.D. Hose
A-102	25	544	1/8" NPT	3/16" I.D. Hose
A-103	25	545	1/8" NPT	1/4" I.D. Hose
A-105	25	—	1/8" NPT	3/8" I.D. Hose
A-111	25	549	1/4" NPT	1/8" I.D. Hose
A-112	25	540	1/4" NPT	3/16" I.D. Hose
A-113	25	541	1/4" NPT	1/4" I.D. Hose
A-114	25	542	1/4" NPT	5/16" I.D. Hose
A-115	25	543	1/4" NPT	3/8" I.D. Hose
A-122	25	537	3/8" NPT	1/4" I.D. Hose
A-123	25	538	3/8" NPT	5/16" I.D. Hose
A-124	25	539	3/8" NPT	3/8" I.D. Hose



Part No.	Std. Pkg.	Western Equivalent Part No.	Male Pipe Thread	Barb Hose Size
A-151	25	550	1/8" NPT	1/8" I.D. Hose
A-152	25	551	1/8" NPT	3/16" I.D. Hose
A-153	25	552	1/8" NPT	1/4" I.D. Hose
A-161	25	—	1/4" NPT	1/8" I.D. Hose
A-162	25	554	1/4" NPT	3/16" I.D. Hose
A-163	25	555	1/4" NPT	1/4" I.D. Hose
A-164	25	556	1/4" NPT	5/16" I.D. Hose
A-165	25	557	1/4" NPT	3/8" I.D. Hose

## HOSE ADAPTORS FOR REGULATOR OR TORCH

### MALE PIPE TO INTERNAL SWIVEL NUT ADAPTORS



Part No.	Std. Pkg.	Western Equivalent Part No.	Male Pipe Thread	Swivel Nut
A-192	10	123	1/4" NPT-Male	Oxygen "B" 9/16"-18RHINT



Part No.	Std. Pkg.	Western Equivalent Part No.	Male Pipe Thread	Swivel Nut
A-192	10	124	1/4" NPT-Male	Fuel Gas "B" 9/16"-18-LH-INT

### INTERNAL SWIVEL NUT TO BARBED HOSE ADAPTORS



Part No.	Std. Pkg.	Western Equivalent Part No.	3/8"-24-INT "A" Size
A-250	10	14-0	Oxygen RH Nut to 1/4" I.D. Hose
A-251	10	14	Fuel Gas LH Nut to 1/4" I.D. Hose

Part No.	Std. Pkg.	Western Equivalent Part No.	9/16"-18-INT "B" Size
A-254	10	24-0	Oxygen RH Nut to 1/4" I.D. Hose
A-255	10	24	Fuel Gas LH Nut to 1/4" I.D. Hose

### BARBED LEAD-HOSE ADAPTORS



Part No.	Std. Pkg.	Western Equivalent Part No.	9/16"-18-Extended Standard "B" Thread	Barb Hose Size
A-50	50	40	Oxygen Right Hand	3/16" I.D.
A-51	50	41	Fuel Gas Left Hand	3/16" I.D.
A-60	50	40-B	Oxygen Right Hand	1/4" I.D.
A-61	50	41-B	Fuel Gas Left Hand	1/4" I.D.

# BRASS HOSE FITTINGS MAXIMUM PRESSURE 200 PSIG

## EXTERNAL HOSE NUT TO INTERNAL SWIVEL NUT

Part No. A-307



Part No. A-300



Part No. A-188

Part No.	Western Equivalent Part No.	Std. Pkg.	External Hose Nuts	Swivel Nut and Nipple
A-300	103	10	Oxygen "A" 3/8"-24-RH-EXT	Oxygen "B" 9/16"-18-RH-INT
A-301	104	10	Fuel Gas "A" 3/8"-24-LH-EXT	Fuel Gas "B" 9/16"-18-LH-INT
A-306	105	10	Oxygen "B" 9/16"-18-RH-EXT	Oxygen "A" 3/8"-24-RH-INT
A-307	106	10	Fuel Gas "B" 9/16"-18-RH-EXT	Fuel Gas "A" 3/8"-24-RH-INT
A-308	—	10	Oxygen "B" 9/16"-18-RH-EXT	Oxygen "C" 7/8"-14-RH-INT

Part No.	Western Equivalent Part No.	Std. Pkg.	External Pipe Thread to Internal Swivel Nut and Nipple - 2-1/2" Long
A-188	153	10	1/4" NPT-EXT to 9/16" - 18-R.H. - INT Oxygen "B"
A-189	154	10	1/4" NPT-EXT to 9/16" - 18-L.H. - INT Fuel Gas "B"

## FEMALE PIPE THREAD TO "A" AND "B" SIZE CONNECTIONS

Internal NPT

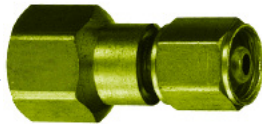

"B" Internal Swivel Nut

Internal NPT

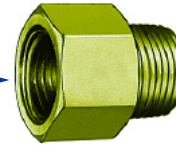

External Hose B Size Coupler

Part No.	Western Equivalent Part No.	Std. Pkg.	INT.-NPT to INT. Swivel Nut
A-228	234	10	1/4" NPT-F to "B"-R.H. Oxygen
A-229	235	10	1/4" NPT-F to "B"-L.H. Fuel Gas

Part No.	Western Equivalent Part No.	Std. Pkg.	INT.-NPT to INT. Coupler
A-238	—	10	1/8" NPT-F to 9/16"-18-R.H. Oxygen "B"
A-242	244	10	1/4" NPT-F to 9/16"-18-R.H. Oxygen "B"
A-243	245	10	1/4" NPT-F to 9/16"-18-L.H. Fuel Gas "B"

## 90° EXTERNAL HOSE NUT TO INTERNAL SWIVEL NUT

Standard "B" Oxygen Nut

Standard "B" Oxygen Hose Coupler

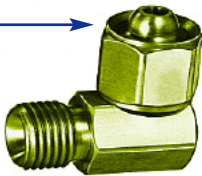

Part No. A-322

Part No.	Western Equivalent Part No.	Std. Pkg.	External Hose Nuts	Swivel Nut and Nipple
A-322	107	10	Oxygen Standard "B" Coupler 9/16"-18-Right Hand-Ext-90°	Oxygen Standard "B" Nut 9/16"-18-Right Hand-Internal
A-323	108	10	Fuel Gas Standard "B" Coupler 9/16"-18-Left Hand-Ext-90°	Fuel Gas Standard "B" Nut 9/16"-18-Left Hand-Internal

## 90° EXTERNAL PIPE TO INTERNAL SWIVEL NUT

External NPT



Internal "B" Oxygen Swivel Nut

Part No.	Western Equivalent Part No.	Std. Pkg.	90° EXT. NPT to "B" Size Nut
A-194	—	10	1/4" NPT-M to 9/16"-18-R.H.-INT Oxygen

## 90° EXTERNAL PIPE TO EXTERNAL "B" COUPLER

External NPT



Standard "B" Oxygen Hose Coupler

Part No.	Western Equivalent Part No.	Std. Pkg.	90° EXT. NPT to "B" Size Nut
A-334	253	10	1/4" NPT-M to 9/16"-18-R.H.-EXT Oxygen
A-335	254	10	1/4" NPT-M to 9/16"-18-R.H.-EXT Fuel Gas

# BRASS HOSE FERRULES, BRACES, CLAMPS

## MAXIMUM PRESSURE 200 PSIG

### ROUND BRASS HOSE FERRULES



Part No.	Western Equivalent Part No.	Std. Pkg.	Inside Diameter	Length	Recommended Crimping Tool
6321	—	100	.330"	1/2"	KT15
833	833	100	.358"	1/2"	KT15
622	622	100	.380"	1/2"	KT15
620	620	100	.410"	1/2"	KT15
769	769	100	.450"	9/16"	KT10, 15 & 28
4750	4750	100	.478"	11/16"	KT10, 15, 18 & 28
624	624	100	.500"	1/2"	KT10, 15 & 28
7322	7322	100	.500"	1"	KT15
625	625	100	.525"	1/2"	KT15
7324	7324	100	.527"	1"	KT15
626	626	100	.548"	31/64"	KT10 & 28
7325	7325	100	.562"	1"	KT10, 15 & 28
3588	3588	100	.564"	3/4"	KT10, 15 & 28
KK	K-K	100	.575"	31/64"	KT10, 15 & 28
7326	7326	100	.593"	1"	KT28
JJ	J-J	100	.600"	1/2"	KT28
II	I-I	100	.625"	1/2"	KT28
7327	7327	100	.625"	1"	KT28

Part No.	Western Equivalent Part No.	Std. Pkg.	Inside Diameter	Length	Recommended Crimping Tool
HH	—	100	.650"	1/2"	KT15
7328	7328	100	.656"	1"	KT15
GG	G-G	100	.675"	33/64"	KT15
7329	7329	100	.687"	1"	KT15
FF	F-F	100	.700"	33/64"	KT15
7330	—	100	.718"	1"	KT15
7330B	7330-B	100	.718"	1"	KT15
EE	E-E	100	.725"	17/32"	KT15
DD	D-D	100	.750"	17/32"	KT15
7331	7331	100	.750"	1"	KT15
7332	7332	100	.781"	1"	
7333	7333	100	.812"	1"	
7244A	7244-A	100	.875"	27/32"	
5029A	5029-A	100	.900"	27/32"	
7242A	7242-A	100	.937"	27/32"	
5028A	—	100	.975"	27/32"	

**NOTE:** Hose diameters may vary, check for proper inside diameter of the ferrules.

### OVAL BRASS DUAL HOSE BRACES



Part No.	Western Equivalent Part No.	Std. Pkg.	Inside Dimension	Length	Metal Gauge
9116	9116	100	.448 x .890	15/32"	.019"
9979	9976	100	.474 x .943	15/32"	.019"
9940P	9940-P	100	.535 x 1.071	3/4"	.024"
9593	9593	100	.593 x 1.109	3/4"	.024"
453	453	100	.593 x 1.238	3/4"	.025"
454	454	100	.700 x 1.325	3/4"	.025"

### BRASS HOSE CLAMPS



Part No.	Western Equivalent Part No.	Std. Pkg.	Hose I.D.	Clamp I.D. Open	Clamp I.D. Closed
HC-500	500	100	3/16"	7/16"	25/64"
HC-501	501	100	1/4"	1/2"	7/16"
HC-503	503	100	3/8"	5/8"	19/32"

**NOTE:** For proper size-The open hose clamp I.D. should be 1/32" larger than the outside diameter of the hose.

# HOSE REPAIR KITS MAXIMUM PRESSURE 200 PSIG

## REPAIR KITS: HOSE CONNECTIONS, CRIMPING TOOLS & PIPE FITTINGS



Part No. RK-5



Part No. RK-27

Part No.	Western Equivalent Part No.	Std. Pkg.	Description
RK-5	CK-20	5	"B" size hose fittings with KT10 Crimping Tool. Contains nuts, nipples, couplers, splicers and ferrules for 1/4" and 3/16" I.D. hose. Includes large size plastic box.
RK-6	CK-1	5	"A" and "B" size hose fittings with KT10 Crimping Tool. Contains nuts, nipples, couplers, splicers and ferrules for 1/4" and 3/16" I.D. hose. <b>Includes large size plastic box.</b>
RK-8	CK-22	5	"B" size hose fittings with KT10 Crimping Tool. Contains nuts, nipples, couplers, splicers and ferrules for 1/4" I.D. hose. Includes large size plastic box.
RK-10	—	5	"B" size hose fittings, less Crimping Tool. Contains hose adaptors, couplers, outlet bushings, nuts, nipples, splicers and ferrules for 1/4" and 3/16" I.D. hose. <b>Includes large size plastic box.</b>
RK-16	CK-3	5	"A" and "B" size hose fittings with KT15 Crimping Tool. Contains nuts, nipples, couplers, splicers and ferrules for 1/4" and 3/16" I.D. hose. <b>Includes large size plastic box.</b>
RK-20	C-2	5	Splicer and ferrule selection with KT10 Crimping Tool. Contains hexagon center splicers and ferrules for 1/4" and 3/16" I.D. hose. <b>Includes small size plastic box.</b>
RK-24	CK-24	5	"B" size hose fittings with KT28 Vice Grip type Crimping Tool. Contains nuts, nipples, couplers, splicers and ferrules for 1/4" and 3/16" I.D. hose. <b>Includes large size plastic box.</b>
RK-26	CK-26	5	"B" size hose fittings with vise-grip type crimping tool for 1/4" I.D. hose. Hose repair kits are shrink-wrapped and have a multi-color cover.
RK-27	CK-S	5	"A" and "B" size hose fitting with KT28 Vise-Grip type Crimping Tool. Contains nuts, nipples, couplers, splicers and ferrules for 1/4" and 3/16" I.D. hose. <b>Includes large size plastic box.</b>
RK-35	CK-7	5	"B" size hose fittings, less Crimping Tools. Contains hose adaptors, couplers, outlet bushings, nuts, nipples, splicers and ferrules for 1/4" and 3/16" I.D. hose. <b>Includes extra large size plastic box.</b>

**NOTE:** Special kits may be supplied with various combinations of hose repair parts upon request.

## GAS LEAK DETECTOR, OXYGEN SAFE



Part No. LD-008

Part No.	Western Equivalent Part No.	Description
LD-008	LT-100	8 oz. reusable plastic applicators.
LD-128	LT-200	1 gallon container for refilling applicators.

## FERRULE CRIMPING TOOLS — HAND MODELS STD. PKG. 10

Part No. KT-10



Part No. KT-15

Part No.	Western Equivalent Part No.	Description
KT-10	C-1	2-Hole Jaws to Crimp Diameters 7/16" and 9/16" on Twin or Single Hose.
KT-15	C-3	13-Hole Jaws to Crimp Diameters 7/32", 9/16" and 11/16" on Twin or Single Hose.

Insert hose with ferrule in proper hole. Press in Vise. Make 1/4 Turn and squeeze.

## WISE GRIP TYPE

STD. PKG. 10



Part No. KT-28

Part No.	Western Equivalent Part No.	Description
KT-28	C-4	2-Hole Jaws to Crimp Diameters 7/16" and 9/16" on Twin or Single Hose.

No Hammer, Vise or Other Tool Needed.

Insert hose with ferrule and splicer or nut and nipple in proper hole.

Offset Tool Approximately 1/8" from end of Ferrule and Squeeze. Make 1/4 Turn and Squeeze Hard Again.

# BRASS PIPE THREAD FITTINGS MAXIMUM PRESSURE 3000

## 90° ELBOW



Ratermann Part No.	Std. Pkg.	Female Threads
FIT-90F18	10	1/8" NPT
FIT-90F14	10	1/4" NPT
FIT-90F12	10	1/2" NPT

## 90° STREET ELBOW



Ratermann Part No.	Std. Pkg.	Female/Male Threads
FIT-SEF18M18	25	1/8" NPT
FIT-90SEF14M14	25	1/4" NPT
FIT-90SEF12M12	25	1/2" NPT

## 45° STREET ELBOW

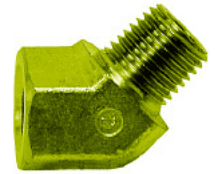

Ratermann Part No.	Std. Pkg.	Female/Male Threads
FIT-45SEF18M18	25	1/8" NPT
FIT-45SEF14M14	25	1/4" NPT

## CAP



Ratermann Part No.	Std. Pkg.	Female Threads
FIT-18CAP	25	1/8" NPT
CAP-PLUG-14	25	1/4" NPT
FIT-38CAP	25	3/8" NPT

## TEE

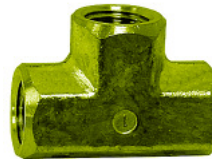

Ratermann Part No.	Std. Pkg.	Female Threads
FIT-TF18	10	1/8" NPT
FIT-TF14	10	1/4" NPT
FIT-TF12	10	1/2" NPT

## STREET TEE

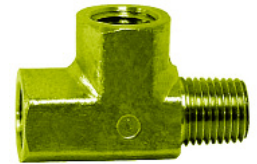

Ratermann Part No.	Std. Pkg.	Two Ports Female One End-Male
FIT-TBLOCK18	25	1/8" NPT
FIT-TBLOCK14	25	1/4" NPT

## CROSS

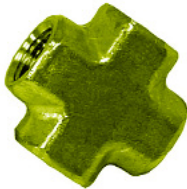

Ratermann Part No.	Std. Pkg.	Female Threads
FIT-X18	10	1/8" NPT
FIT-X14	10	1/4" NPT

## PIPE EXTENSION



Ratermann Part No.	Std. Pkg.	Male/Female NPT Threads
FIT-PEF18M18	10	1/8" x 1/8" 2 1/2" Long
FIT-PEF14M14	10	1/4" x 1/4" 3" Long

## HEX HEAD PLUG



Ratermann Part No.	Std. Pkg.	Female Threads
FIT-18PLUG	25	1/8" NPT
FIT-14PLUG	25	1/4" NPT
FIT-12PLUG	10	1/2" NPT

## ADAPTOR



Ratermann Part No.	Std. Pkg.	Female Thread	Male Thread
FIT-F14M14	25	1/4" NPT	1/4" NPT
FIT-F18M18	25	1/8" NPT	1/8" NPT
FIT-M14M18	25	1/4" NPT	1/8" NPT
FIT-F38M14	10	3/8" NPT	1/4" NPT
FIT-F12M14	10	1/2" NPT	1/4" NPT

## CONNECTOR



Ratermann Part No.	Std. Pkg.	Female Thread	Female Thread
FIT-F18F18	25	1/8" NPT	1/8" NPT
FIT-F14F18	25	1/4" NPT	1/8" NPT
FIT-F14F14	25	1/4" NPT	1/4" NPT
FIT-F12F14	10	1/2" NPT	1/4" NPT
FIT-F12F12	10	1/2" NPT	1/2" NPT

## REDUCER BUSHING



Ratermann Part No.	Std. Pkg.	Female Thread	Male Thread
FIT-F18M14	25	1/8" NPT	1/4" NPT
FIT-F14M38	25	1/4" NPT	3/8" NPT
FIT-F14M12	10	1/4" NPT	1/2" NPT
FIT-F38M12	10	3/8" NPT	1/2" NPT
FIT-F14M34	10	1/4" NPT	3/4" NPT
FIT-F12M34	10	1/2" NPT	3/4" NPT

\*NOTE: Pressure Ratings only cover Compressed Gases.

**STAINLESS STEEL PIPE THREAD FITTINGS MAXIMUM PRESSURE 3000**  
**HEX BRASS NIPPLE** **ROUND BRASS NIPPLES**



Ratermann Part No.	Std. Pkg.	Male Thread	Male Thread
FIT-M18M18	25	1/8" NPT	1/8" NPT
FIT-M14M18	25	1/4" NPT	1/8" NPT
FIT-M14M14	25	1/4" NPT	1/4" NPT
FIT-M38M38	25	3/8" NPT	3/8" NPT
FIT-M38M14	25	3/8" NPT	1/4" NPT
FIT-M12M38	25	1/2" NPT	1/4" NPT
FIT-M12M38	25	1/2" NPT	3/8" NPT
FIT-M12M12	25	1/2" NPT	1/2" NPT



Ratermann Part No.	Std. Pkg.	Male Thread	Length
FIT-NPM-1815	25	1/8" NPT	1-1/2" Long
FIT-NPM-1415	25	1/4" NPT	1-1/2" Long
FIT-NPM-1420	25	1/4" NPT	2" Long
FIT-NPM-1425	25	1/4" NPT	2-1/2" Long
FIT-NPM-1430	25	1/4" NPT	3" Long
FIT-NPM-1435	25	1/4" NPT	3-1/2" Long

**TYPE 316 STAINLESS STEEL PIPE THREAD FITTINGS MAXIMUM PRESSURE 6000 P.S.I.G.**

**STAINLESS 90° ELBOW**



Ratermann Part No.	Std. Pkg.	Female Threads
FIT-SS90XF14	1	1/4" NPT

**STAINLESS 90° STREET ELBOW**



Ratermann Part No.	Std. Pkg.	Female/Male Threads
FIT-SS90SEF4M4	1	1/4" NPT

**STAINLESS 45° STREET ELBOW**



Ratermann Part No.	Std. Pkg.	Male/Female Threads
FIT-SS45SEF4M4	1	1/4" NPT

**STAINLESS CROSS**



Ratermann Part No.	Std. Pkg.	Female Threads
FIT-SSXF14	1	1/4" NPT

**STAINLESS TEE**



Ratermann Part No.	Std. Pkg.	Female Threads
FIT-SSTF14	1	1/4" NPT

**STAINLESS CONNECTOR**



Ratermann Part No.	Std. Pkg.	Female Threads
FIT-SSF14F14	10	1/4" NPT

**STAINLESS REGULATOR OUTLET**



Ratermann Part No.	Std. Pkg.	Male Threads
FIT-SSM14-916	25	1/4" NPT-9/16-18RH Hose Fitting

**STAINLESS HEX NIPPLE**



Ratermann Part No.	Std. Pkg.	Male Threads
FIT-SSM14M14	1	1/4" NPT

**STAINLESS ADAPTOR**



Ratermann Part No.	Std. Pkg.	Female/Male Threads
FIT-SSF14M14	10	1/4" NPT

\*NOTE: Pressure Ratings only cover Compressed Gases.

**STANDARD HOSE CONNECTIONS FOR INERT ARC WELDERS** **MAXIMUM PRESSURE 200**

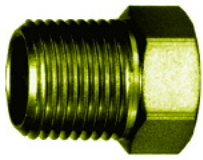

Part No. N-2400



Part No. NP-73



Part No. A-415



Part No. A-424



Part No. C-124



Part No. N-26

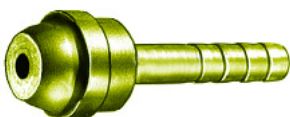

Part No. NP-65

**INERT ARC HOSE NUTS**

Part No.	Western Equivalent Part No.	Std. Pkg.	External Thread	Use With
N-14	AW-21A	50	3/8"-24-Right Hand "A"	NP66, 67, "A" Size Cable Connectors
N-15	AW-21	50	3/8"-24-Left Hand "A"	NP66, 67, "A" Size Cable Connectors
N-2400	AW-14A	50	5/8"-18-Right Hand "B"	NP69, 70, 72, 73, 74, 76, "B" Size
N-2500	AW-14	50	5/8"-18-Left Hand "B"	NP69, 70, 72, 73, 74, 76, "B" Size
N-3600	AW-10A	25	7/8"-14-Right Hand "C"	NP606, "C" Size Cable Connectors
N-3700	AW-10	25	7/8"-14-Left Hand "C"	NP606, "C" Size Cable Connectors

**INERT ARC BARB HOSE NIPPLES**

Part No.	Western Equivalent Part No.	Std. Pkg.	Size	Hose Size	Use With Hose Nuts
NP-66	AW-24	50	Aircraft "A"	1/8" I.D.	N14, 15
NP-68	AW-40	50	Standard "B"	1/8" I.D. Undersize	N2400, 2500
NP-69	AW-16	50	Standard "B"	1/8" I.D.	N2400, 2500
NP-70	AW-18	50	Standard "B"	3/16" I.D.	N2400, 2500
NP-72	AW-17	50	Standard "B"	1/4" I.D.	N2400, 2500
NP-73	AW-47	25	Standard "B"	Special 1/4" Barb x 2-1/4" Long	N2400, 2500
NP-74	AW-20	50	Standard "B"	5/16" I.D.	N2400, 2500
NP-76	AW-19	50	Standard "B"	3/8" I.D.	N2400, 2500

**INERT ARC ADAPTORS**

Part No.	Western Equivalent Part No.	Std. Pkg.	Description	
A-402	AW-152	10	1/8"-NPT-Male	5/8"-18-Right Hand-INT (Inert Gas) "B"
A-404	AW-15A	25	1/4"-NPT-Male	5/8"-18-Right Hand-INT (Inert Gas) "B"
A-405	AW-15	25	1/4"-NPT-Male	5/8"-18-Left Hand-INT (Air-Water) "B"
A-414	AW-427	10	1/4"-NPT-Male	5/8"-18-Right Hand-External "B"
A-415	AW-428	10	1/4"-NPT-Male	5/8"-18-Left Hand-External "B"
A-424	AW-407	10	5/8"-18-RH-EXT-90°	5/8"-18-Right Hand-Internal "B"

**INERT ARC HOSE COUPLERS**

Part No.	Western Equivalent Part No.	Std. Pkg.	Description	
C-118	AW-430A	10	3/8"-24-Right Hand-Internal "A"	3/8"-24-Right Hand-Internal "A"
C-119	AW-431A	10	3/8"-24-Left Hand-Internal "A"	3/8"-24-Left Hand-Internal "A"
C-124	AW-430B	10	1/4"-NPT-Internal	5/8"-24-Right Hand-Internal "B"
C-125	AW-431B	10	1/4"-NPT-Internal	5/8"-18-Left Hand-Internal "B"
C-126	AW-430	10	5/8"-18-Right Hand-Internal "B"	5/8"-18-Right Hand-Internal "B"
C-127	AW-431	10	5/8"-18-Left Hand-Internal "B"	5/8"-18-Left Hand-Internal "B"
C-144	AW-430C	10	7/8"-14-Right Hand-Internal "C"	7/8"-14-Right Hand-Internal "C"
C-145	AW-431C	10	7/8"-14-Left Hand-Internal "C"	7/8"-14-Left Hand-Internal "C"

**AIR-WATER FITTINGS FOR INERT ARC AIR-WATER NUT**

Part No.	Western Equivalent Part No.	Std. Pkg.	Thread	Use With
N-26	AW-7	50	5/8"-18-Right Hand-Internal	NP65, NP595, NP596

**INERT ARC BARB HOSE NIPPLES**

Part No.	Western Equivalent Part No.	Std. Pkg.	Size	Hose Size	Use With Hose Nuts
NP-65	—	25	Standard "B"	1/8" I.D. - .190" O.D.x1-13/32 Long	N26

**BRASS HOSE FITTINGS MAXIMUM PRESSURE 200 PSIG**  
**CONNECTIONS FOR INERT ARC WELDERS MAXIMUM PRESSURE 200 P.S.I.G.**

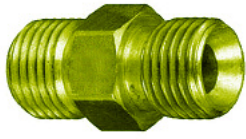

Part No. C-134



Part No. A-450

**AIR-WATER FITTINGS FOR INERT ARC**

**AIR-WATER COUPLER**

Part No.	Std. Pkg.	Western Equivalent Part No.	Coupling	To
C-130	50	AW-30	5/8"-18-Right Hand-External	5/8"-18-Right Hand-External
C-134	50	AW-34	5/8"-18-Right Hand-External	9/16"-18-Right Hand-External
C-135	50	AW-35	5/8"-18-Left Hand-External	9/16"-18-Left Hand-External

**AIR-WATER ADAPTER**

Part No.	Std. Pkg.	Western Equivalent Western Part No.	Description
A-450	50	AW-32	1/4" NPT-Male 5/8"-18-Right Hand-External

Std. Pkg. 10

**HOSE ADAPTORS FOR REGULATOR OR TORCH**

Std. Pkg. 10

Part No.	Western Equivalent Part No.	Description
A-462	AW-403	5/8"-18-RH-External Swivel Nut "B"
A-466	—	5/8"-18-RH-External Swivel Nut "B"
A-470	—	5/8"-18-LH-External Swivel Nut "B"
A-474	—	5/8"-18-LH-External Swivel Nut "B"

Part No.	Western Equivalent Part No.	Description
A-478	AW-405	5/8"-18-RH Internal "B"
A-479	—	5/8"-18-RH Internal "B"
A-482	—	5/8"-18-RH Internal "B"

**BRASS POWER CABLE HOLDER ADAPTORS**



Part No. PCH-10

Part No.	Std. Pkg.	Western Equivalent Part No.	Description
PCH-8	10	AW-108	Inert Gases, 7/8"-14-R.H.-INT (C-size) to 5/8"-18-R.H.-INT (B-size)
PCH-9	10	AW-109	Air/Water, 7/8"-14-L.H.-INT (C-size) to 5/8"-18-L.H.-INT (B-size).
PCH-10	10	AW-110	Inert Gases, 5/8"-18-R.H.-INT (B-size) to 3/8"-24-R.H.-INT (A-size).

**POWER CABLE NIPPLES & CONNECTOR ASSEMBLIES MAXIMUM PRESSURE 200 P.S.I.G.**

**BRASS POWER CABLE NIPPLES & CONNECTOR ASSEMBLIES**



Part No. CN-10

Part No.	Std. Pkg.	Western Equivalent Part No.	One Piece All Brass "A" & "B" Size Nipple And Connector for Crimping Cable
CN-6	10	AW-45	A" Size Nipple x .250" O.D. Tube and max. .203" Diameter cable hole.
CN-10	10	AW-46	B" Size Nipple x .375" O.D. Tube (.420" O.D. Barbs) and Max. .312" Diameter cable hole.

**POWER CABLE NIPPLES & CONNECTOR ASSEMBLIES**    **MAXIMUM PRESSURE 200**

**BRASS NIPPLE & COPPER TUBE ASSEMBLY**



Part No. CN-16



Part No. CN-28



Part No. CN-36

Part No.	Std. Pkg.	Western Equivalent Part No.	"B" Size Brass Nipples Soldered to Copper Tube for Crimping Cable Use with Nuts N-2400 & N-2500
----------	-----------	-----------------------------	--

CN-16	10	AW-49	B-size Brass Nipple x .225" O.D. Copper Tube and Max. .140" Dia. Cable Hole.
CN-20	10	AW-50	B-size Brass Nipple x .322" O.D. Copper Tube and Max. .246" Dia. Cable Hole.

Part No.	Std. Pkg.	Western Equivalent Part No.	"C" Size Brass Nipples Soldered to Copper Tube for Crimping Cable Use with Nuts N36 & N37
----------	-----------	-----------------------------	--

CN-28	10	AW-26	C-size Brass Nipple x .225" O.D. Copper Tube and Max. .140" Dia. Cable Hole.
CN-32	10	AW-54	C-size Brass Nipple x .263" O.D. Copper Tube and Max. .166" Dia. Cable Hole.
CN-36	10	AW-23	C-size Brass Nipple x .322" O.D. Copper Tube and Max. .246" Dia. Cable Hole.

**POWER CABLE NUT, NIPPLE & COPPER TUBE ASSEMBLY**



Part No. CN-48



Part No. CN-54



Part No. CN-60



Part No. CN-68



Part No. CN-72

Part No.	Std. Pkg.	Western Equivalent Part No.	Description
----------	-----------	-----------------------------	-------------

CN-48	10	AW-22A	A-size Copper Nipple with 3/8" -24 R.H. Ext. Brass Nut x .322" O.D. Copper Tube and Max. .246" Cable Hole.
CN-49	10	AW-22	A-size Copper Nipple with 3/8" -24 L.H. Ext. Brass Nut x .322" O.D. Copper Tube and Max. .246" Cable Hole.
CN-54	10	AW-25	A-size Copper Nipple with 3/8" -24 R.H. Int. Brass Nut x .322" O.D. Copper Tube and Max. .246" Cable Hole.

Part No.	Std. Pkg.	Western Equivalent Part No.	Brass Swivel Nut & Brass Nipple Soldered to Copper Tube For Crimping Cable
----------	-----------	-----------------------------	--

CN-60	10	AW-53	.21" Dia. Brass Nipple with 1/4" - 28 Int. Brass Nut x .225 O.D. Copper Tube and Max. .140" Cable Hole.
CN-68	10	AW-51	.37" Dia. Brass Nipple with 7/16" - 20 Int. Brass Nut x .375 O.D. Copper Tube and Max. .245" Cable Hole.
CN-72	10	AW-56	B-size Brass Nipple with 5/8" - 18 Ext. Brass not x .468 O.D. Copper Tube and Max. .328" Cable Hole

**BRITISH STYLE FITTINGS**



Part No. BN-020



Part No. BNP-010



Part No. BA-540

Part No.	Std. Pkg.	Western Equivalent Part No.	Description
----------	-----------	-----------------------------	-------------

BA-540	10	BR-540	British oxygen cylinder to CGA-540 oxygen adaptor, 3,000 P.S.I.G.
BA-580	10	BR-580	British nitrogen cylinder to CGA-580 oxygen adaptor, 3,000 P.S.I.G.
BH-073	10	BR-662PM	Hand-tight plastic grip, British helium, 3,000 P.S.I.G.
BN-020	10	BR-7	British oxygen hose nut, 200 P.S.I.G., R.H.
BN-021	10	BR-8	British fuel gas hose nut, 200 P.S.I.G., L.H.
BN-069	10	BR-15-2	British fuel gas cylinder nut, 500 P.S.I.G., L.H.
BN-071	10	BR-62	British oxygen cylinder nut, 3,000 P.S.I.G., R.H.
BNP-010	10	BR-17	British hose nipple, 1/4" I.D. hose, 200 P.S.I.G.
BNP-014	10	BR-216	British hose nipple, 5/16" I.D. hose, 200 P.S.I.G.
BNP-188	10	BR-15-8	British oxygen, helium, nitrogen nipple x 2-1/2" long, 3,000 P.S.I.G., 1/4" NPT
BNP-190W	10	BR-615-3	British helium, nitrogen nipple with "O" ring x 3-1/2" long, 3,000 P.S.I.G., 1/4" NPT

**NOTE:** Other foreign fittings available upon request (DIN, French, etc.)

# REGULATOR INLET NUTS & NIPPLES BRASS & CHROME PLATED

## CGA-180 3000 P.S.I.G.

NON-CORROSIVE GASES, SMALL CYLINDERS



Ratermann Part No.	Std. Pkg.	CGA-180 Nut Thread
CGA-180NUTN	20	.625"-18UNF-2B-RH-INT.
CGA-180NUTMN	20	.625"-18UNF-2B-RH-INT.

Std. Pkg. -20	NIPPLES & WASHER	
CGA-180NIPPLE18N	1/8" NPT	1-3/4" Long
CGA-180NIPPLE18MNP	1/8" NPT	1-3/4" Long
CGA-180PTFEWASH	PTFE Washer	

## CGA-200 3000 P.S.I.G.

ACETYLENE, "MC" SIZE



Ratermann Part No.	Std. Pkg.	CGA-200 Nut Thread
CGA-200NUT	20	.628"-20NGO-RH-INT.

Std. Pkg. -20	NIPPLES	
CGA-200NIPPLE	1/8" NPT	1-1/4" Long
CGA-200NIPPLE716	7/16"-20 UNF	1-1/4"

## CGA-280 3000 P.S.I.G.

ACETYLENE, "MC" SIZE



Ratermann Part No.	Std. Pkg.	CGA-280 Nut Thread
CGA-280NUTN	20	.750"-14NGO-RH-INT.
CGA-280NUTMN	20	.750"-14NGO-RH-INT.

Std. Pkg. -20	NIPPLES	
CGA-280NIPPLE14N	1/4" NPT	2-1/2" Long
CGA-280NIPPLE14MNP	1/4" NPT	2-1/2" Long

## CGA-296 3000 P.S.I.G.

INDUSTRIAL OXYGEN MIXTURES



Ratermann Part No.	Std. Pkg.	CGA-296 Nut Thread
CGA-296NUT	20	.830"-14UNS-2A-RH-EXT.
CGA-296NUTMN	20	.830"-14UNS-2A-RH-EXT.

Std. Pkg. -20	NIPPLES	
CGA-296NIPPLE14NP	1/4" NPT	3" Long
CGA-296NIPPLE14MNP	1/4" NPT	3" Long

## CGA-300 Acetylene 250 P.S.I.G.

ACETYLENE



Ratermann Part No.	Std. Pkg.	CGA-300 Nut Thread
CGA-300NUTN	20	.830"-14NGO-RH-INT.
CGA-300NUTMN	20	.830"-14NGO-RH-INT.

Std. Pkg. -20	NIPPLES	
CGA-300NIPPLE142N	1/4" NPT	2" Long
CGA-300NIPPLE14212NP	1/4" NPT	2-1/2" Long
CGA-300NIPPLE14312NP	1/4" NPT	3-1/2" Long
CGA-300NIPPLE14312MNP	1/4" NPT	3-1/2" Long
CGA-300NIPPLE12214NP	1/2"-27UNS	2-1/4" Long

## CGA-320 3000 P.S.I.G.

CARBON DIOXIDE

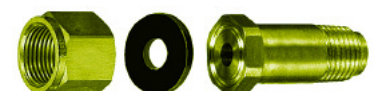

Ratermann Part No.	Std. Pkg.	CGA-320 Nut Thread
CGA-320NUT	20	.830"-14NGO-RH-INT.
CGA-320NUTMN	20	.830"-14NGO-RH-INT.

Std. Pkg. -20	NIPPLES & WASHER	
CGA-320NIPPLE14NP	1/4" NPT	2" Long
CGA-320NIPPLE14MNP	1/4" NPT	2" Long
CGA-320NIPPLE	1/4" NPT	2-1/2" Long
CGA-320NIPPLE143NP	1/4" NPT	3" Long
CGA-320NIPPLE143MNP	1/4" NPT	3" Long
CGA-320NIPPLE12NP	1/2" NPT	2-1/2" Long
Co2-TWSEAL	Fiber or PTFE Washer	

## CGA-326 3000 P.S.I.G.

NITROUS OXIDE

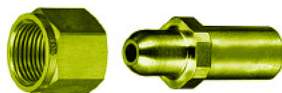

Ratermann Part No.	Std. Pkg.	CGA-326 Nut Thread
CGA-326NUT	20	.830"-14NGO-RH-INT.
CGA-326NUTMN	20	.830"-14NGO-RH-INT.

Std. Pkg. -20	NIPPLES	
CGA-326NIPPLE14NP	1/4" NPT	2-1/8" Long
CGA-326NIPPLE	1/4" NPT	2-1/2"
CGA-326NIPPLE14MNP	1/4" NPT	2-1/2"
CGA-326NIPPLE143NP	1/4" NPT	3"

## CGA-330 3000 P.S.I.G.

NON-CORROSIVE GASES



Ratermann Part No.	Std. Pkg.	CGA-330 Nut Thread
CGA-330NUT	20	.830"-14NGO-LH-INT.
CGA-330NUTMN	20	.830"-14NGO-LH-INT.

Std. Pkg. -20	NIPPLES & WASHER	
CGA-330NIPPLE14NP	1/4" NPT	2" Long
CGA-330NIPPLE	1/4" NPT	2-1/2"
CGA-330NIPPLE14MNP	1/4" NPT	2-1/2"
Co2-TWSEAL	Fiber or PTFE Washer	

## CGA-346 3000 P.S.I.G.

AIR



Ratermann Part No.	Std. Pkg.	CGA-346 Nut Thread
CGA-346NUT	20	.830"-14NGO-RH-INT.
CGA-346NUTMN	20	.830"-14NGO-RH-INT.

Std. Pkg. -20	NIPPLES	
CGA-346NIPPLE	1/4" NPT	2-1/2" Long
CGA-346NIPPLE14MNP	1/4" NPT	2-1/2" Long
CGA-346NIPPLE14NP	1/4" NPT	3-1/2"
CGA-346NIPPLE14312MNP	1/4" NPT	3-1/2"
CGA-346NIPPLE12214	1/2"-27UNS	2-1/2"

Refer to Page 13B-19 for Filter and Washer Information  
MN & MNP indicates Chrome Plated Brass

# REGULATOR INLET NUTS & NIPPLES BRASS & CHROME PLATED

## CGA-347 3001-5500 P.S.I.G.

AIR



Ratermann Part No.	Std. Pkg.	CGA-347 Nut Thread
CGA-347NUT	20	.830"-14NGO-RH-INT.
CGA-347NUTMN	20	.830"-14NGO-RH-INT.

Std. Pkg. -20

NIPPLES

BH-347NIPPLE	1/4" NPT	3" Long
BH-347NIPPLEMN	1/4" NPT	3" Long

## CGA-500 3000 P.S.I.G.

MEDICAL MIXTURES



Ratermann Part No.	Std. Pkg.	CGA-500 Nut Thread
CGA-500NUT	20	.880"-14NGO-RH-EXT.
CGA-500NUTMN	20	.880"-14NGO-RH-EXT.

Std. Pkg. -20

NIPPLES

CGA-500NIPPLE	1/4" NPT	2-1/2" Long
---------------	----------	-------------

## CGA-540 3000 P.S.I.G.

OXYGEN



Ratermann Part No.	Std. Pkg.	CGA-540 Nut Thread
CGA-540NUT	20	.908"-14NGO-RH-INT.

Std. Pkg. -20

NIPPLES

CGA-540NIPPLE	1/4" NPT	2-1/16" Long
---------------	----------	--------------

## CGA-350 3000 P.S.I.G.

HYDROGEN/METHANE



Ratermann Part No.	Std. Pkg.	CGA-350 Nut Thread
CGA-350NUT	20	.830"-14NGO-LH-INT.
CGA-350NUTMN	20	.830"-14NGO-LH-INT.

Std. Pkg. -20

NIPPLES

CGA-350NIPPLE218	1/4" NPT	2-1/8" Long
CGA-350NIPPLE212NP	1/4" NPT	2-1/2"
CGA-350NIPPLE3NP	1/4" NPT	3"
CGA-350NIPPLE3MNP	1/4" NPT	3"
CGA-350NIPPLE	1/4" NPT	3-1/2"
CGA-350NIPPLE312MNP	1/4" NPT	3-1/2"
CGA-350NIPPLE122212NP	1/2"-27UNS	2-1/2"

## CGA-510 Acetylene 250 P.S.I.G. Propane 500 P.S.I.G.

ACETYLENE/PROPANE



Ratermann Part No.	Std. Pkg.	CGA-510 Nut Thread
CGA-510NUT	20	.880"-14NGO-LH-EXT.
CGA-510NUTMN	20	.880"-14NGO-LH-EXT.
CGA-680NUT	20	Alternate 7/8" HEX

Std. Pkg. -20

NIPPLES

CGA-500NIPPLE	1/4" NPT	2-1/2" Long
CGA-510NIPPLE	1/4" NPT	3-1/2"

## CGA-415 250 P.S.I.G.

CANADIAN ACETYLENE

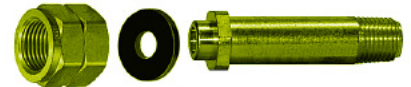

Ratermann Part No.	Std. Pkg.	CGA-415 Nut Thread
CGA-415NUT	20	.855"-14NGO-LH-INT.

Std. Pkg. -20

NIPPLES

CGA-415NIPPLE	1/8" NPT	2-1/2" Long
CGA-415WASHER	Fiber Washer	

## CGA-520 250 P.S.I.G.

ACETYLENE, "B" SIZE



Ratermann Part No.	Std. Pkg.	CGA-520 Nut Thread
CGA-520NUT	20	.899"-18NGO-RH-INT.

Std. Pkg. -20

NIPPLES

CGA-520NIPPLE	1/4" NPT	1-3/4" Long
---------------	----------	-------------

## CGA-555 3000 P.S.I.G.

PROPANE, LIQUID WITHDRAWAL



Ratermann Part No.	Std. Pkg.	CGA-555 Nut Thread
CGA-550NUTN	20	.908"-14NGO-LH-INT.
CGA-550NUTMN	20	.908"-14NGO-LH-INT.

Std. Pkg. -20

NIPPLES

CGA-540NIPPLE	1/4" NPT	2-1/16" Long
CGA-540NIPPLEMNP	1/4" NPT	2-1/16" Long
CGA-540NIPPLENP	1/4" NPT	2-1/2"
CGA-540NIPPLE212MNP	1/4" NPT	2-1/2"
CGA-540NIPPLE3NP	1/4" NPT	3"
CGA-540NIPPLE3MNP	1/4" NPT	3"

Refer to Page 13B-19 for Filter and Washer Information  
MN & MNP indicates Chrome Plated Brass

# REGULATOR INLET NUTS & NIPPLES BRASS & CHROME PLATED

## CGA-577 3001-4000 P.S.I.G.

### OXYGEN



Ratermann Part No.	Std. Pkg.	CGA-577 Nut Thread
CGA-577NUT	10	.965"-14NGO-RH-INT.

### Std. Pkg. -10

### NIPPLES

CGA-577NIPPLE	1/4" NPT	3" Long
---------------	----------	---------

## CGA-580 3000 P.S.I.G.

### INERT GASES



Ratermann Part No.	Std. Pkg.	CGA-580 Nut Thread
CGA-580NUT	20	.960"-14NGO-RH-EXT.

### Std. Pkg. -20

### NIPPLES

CGA-580NIPPLE	1/4" NPT	2-1/2" Long
CGA-580NIPPLE	1/4" NPT	3"

## CGA-590 3000 P.S.I.G.

### INDUSTRIAL AIR



Ratermann Part No.	Std. Pkg.	CGA-590 Nut Thread
CGA-590NUT	20	.960"-14NGO-LH-INT.

### Std. Pkg. -20

### NIPPLES

CGA-590NIPPLE	1/4" NPT	2-1/2" Long
CGA-590NIPPLE	1/4" NPT	3"

## CGA-660 3000 P.S.I.G.

### REFRIGERANT GASES



Ratermann Part No.	Std. Pkg.	CGA-660 Nut Thread
CGA-660NUT	10	1.035"-14NGO-RH-INT.

### Std. Pkg. -20

### NIPPLES & WASHERS

CGA-660NIPPLE134NP	1/4" NPT	1-3/4" Long
CGA-660NIPPLE212NP	1/4" NPT	2-1/2"
CGA-660PTFEWASHER	PTFE Washer	

## CGA-677 5501-7500 P.S.I.G.

### ARGON, NITROGEN & HELIUM



Ratermann Part No.	Std. Pkg.	CGA-677 Nut Thread
CGA-677NUT	10	1.035"-14NGO-LH-INT.

### Std. Pkg. -10

### NIPPLES

CGA-677NIPPLE	1/4" NPT	2-1/2" Long
---------------	----------	-------------

## CGA-680 3001-5500 P.S.I.G.

### ARGON/HELIUM/NITROGEN



Ratermann Part No.	Std. Pkg.	CGA-680 Nut Thread
CGA-680NUT	10	1.040"-14NGO-RH-EXT.

### Std. Pkg. -10

### NIPPLES

CGA-680NIPPLE	1/4" NPT	2-1/2" Long
---------------	----------	-------------

## CGA-695 3001-5500 P.S.I.G.

### HYDROGEN/METHANE



Ratermann Part No.	Std. Pkg.	CGA-695 Nut Thread
CGA-695NUT	10	1.040"-14NGO-LH-EXT.

### Std. Pkg. -10

### NIPPLES

CGA-695NIPPLE212NP	1/4" NPT	2-1/2" Long
CGA-695NIPPLE3NP	1/4" NPT	3"

## CGA-701 4001-5500 P.S.I.G.

### OXYGEN



Ratermann Part No.	Std. Pkg.	CGA-701 Nut Thread
CGA-701NUT	10	1.108"-18NGO-RH-INT.

### Std. Pkg. -10

### NIPPLES

CGA-701NIPPLE3NP	1/4" NPT	3" Long
------------------	----------	---------

## CGA-702 5501-7500 P.S.I.G.

### AIR



Ratermann Part No.	Std. Pkg.	CGA-702 Nut Thread
CGA-702NUT	10	1.120"-14NGO-RH-EXT.
CGA-702NUTMN	10	1.120"-14NGO-RH-EXT.

### Std. Pkg. -10

### NIPPLES

CGA-702NIPPLE212NP	1/4" NPT	2-1/2" Long
CGA-702NIPPLE3NP	1/4" NPT	3"
CGA-702NIPPLE3MNP	1/4" NPT	3"
CGA-702NIPPLE	1/4" NPT	3-1/2"

Refer to Page **13B-19** for Filter and Washer Information  
 MN & MNP indicates Chrome Plated Brass

**CYLINDER CONNECTIONS: REGULATOR INLET NUTS & NIPPLES COUNTERSUNK FOR**

**CGA-296 3000 P.S.I.G.**

**INDUSTRIAL OXYGEN MIXTURES**



Ratermann Part No.	Std. Pkg.	CGA-296 Nut Thread
CGA-296NUT	20	.830 14UNS-RH-EXT.
<b>Std. Pkg.-20 NIPPLES 1 1/4" Long</b>		
PH-296CNIPPLE	20	5/16" O.D. Tube

**CGA-300 250 P.S.I.G.**

**ACETYLENE**



Ratermann Part No.	Std. Pkg.	CGA-300 Nut Thread
CGA-300NUT	20	.830 14NGO-RH-INT.
<b>Std. Pkg.-20 NIPPLES 1 1/4" Long</b>		
PH-300CNIPPLE	20	1/4" O.D. Tube

**CGA-320 3000 P.S.I.G.**

**CARBON DIOXIDE**



Ratermann Part No.	Std. Pkg.	CGA-320 Nut Thread
CGA-320NUT	20	.830 14NGO-RH-INT.
<b>Std. Pkg.-20 NIPPLES 2 1/2" Long</b>		
PH-320CNIPPLE	20	1/4" O.D. Tube

**CGA-326 3000 P.S.I.G.**

**NITROUS OXIDE**



Ratermann Part No.	Std. Pkg.	CGA-326 Nut Thread
CGA-326NUT	20	.830 14NGO-RH-INT.
<b>Std. Pkg.-20 NIPPLES 1 1/4" Long</b>		
PH-326CNIPPLE	20	1/4" O.D. Tube

**CGA-346 3000 P.S.I.G.**

**AIR**



Ratermann Part No.	Std. Pkg.	CGA-346 Nut Thread
CGA-346NUT	20	.830 14NGO-RH-INT.
<b>Std. Pkg.-20 NIPPLES 1 1/4" Long</b>		
PH-346CNIPPLE	20	1/4" O.D. Tube

**CGA-347 5500 P.S.I.G.**

**AIR**



Ratermann Part No.	Std. Pkg.	CGA-347 Nut Thread
CGA-347NUT	20	.830 14NGO-RH-INT.
<b>Std. Pkg.-20 NIPPLES 1 1/4" Long</b>		
PH-347CNIPPLE	20	1/4" O.D. Tube

**CGA-350 3000 P.S.I.G.**

**HYDROGEN/METHANE**

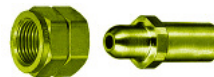

Ratermann Part No.	Std. Pkg.	CGA-350 Nut Thread
CGA-350NUT	20	.830 14NGO-LH-INT.
<b>Std. Pkg.-20 NIPPLES 1 1/4" Long</b>		
PH-350CNIPPLE	20	1/4" O.D. Tube

**CGA-500 3000 P.S.I.G.**

**MEDICAL MIXTURE**



Ratermann Part No.	Std. Pkg.	CGA-500 Nut Thread
CGA-500NUT	20	.830 14NGO-RH-EXT.
<b>Std. Pkg.-20 NIPPLES 1 1/4" Long</b>		
PH-500CNIPPLE	20	1/4" O.D. Tube

**CGA-510 3000 P.S.I.G.  
ACETYLENE 250 P.S.I.G.  
PROPANE 500 P.S.I.G.**

**ACETYLENE/PROPANE**



Ratermann Part No.	Std. Pkg.	CGA-510 Nut Thread
CGA-510NUT	20	.830 14NGO-LH-EXT.
<b>Std. Pkg.-20 NIPPLES 1 1/4" Long</b>		
PH-580NIPPLE	20	1/4" O.D. Tube

**CGA-520 250 P.S.I.G.**

**ACETYLENE, "B" SIZE**



Ratermann Part No.	Std. Pkg.	CGA-520 Nut Thread
CGA-520NUT	20	.899 18NGO-RH-INT.
<b>Std. Pkg.-20 NIPPLES 1 1/4" Long</b>		
PH-520CNIPPLE	20	1/4" O.D. Tube

**CGA-540 3000 P.S.I.G.**

**OXYGEN**



Ratermann Part No.	Std. Pkg.	CGA-540 Nut Thread
CGA-540NUT	20	.908 14NGO-RH-INT.
<b>Std. Pkg.-20 NIPPLES 1.109" Long</b>		
PH-540CNIPPLE	20	1/4" O.D. Tube

**CGA-555 3000 P.S.I.G.**

**PROPANE, LIQUID WITHDRAWAL**



Ratermann Part No.	Std. Pkg.	CGA-500 Nut Thread
CGA-555NUT	20	.908 14NGO-LH-INT.
<b>Std. Pkg.-20 NIPPLES 1 1/4" Long</b>		
PH-590CNIPPLE	20	1/4" O.D. Tube

**CGA-580 3000 P.S.I.G.**

**ARGON/HELIUM/NITROGEN**



Ratermann Part No.	Std. Pkg.	CGA-580 Nut Thread
CGA-580NUT	20	.960 14NGO-RH-EXT.
<b>Std. Pkg.-20 NIPPLES 1 1/4" Long</b>		
PH-580NIPPLE	20	1/4" O.D. Tube

**CGA-590 3000 P.S.I.G.**

**INDUSTRIAL AIR**



Ratermann Part No.	Std. Pkg.	CGA-590 Nut Thread
CGA-590NUT	20	.960 14NGO-LH-EXT.
<b>Std. Pkg.-20 NIPPLES 1 1/4" Long</b>		
PH-580NIPPLE	20	1/4" O.D. Tube

**RATERMANN PART NO. CGA-SNAPRING**  
SNAP RINGS are available for these grooved nipples to hold the nuts in place.  
**STD. PKG. -25**

# STAINLESS STEEL COUNTERSUNK NIPPLES, REGULATOR NIPPLES & NUTS

## CGA-320 3000 P.S.I.G.

### CARBON DIOXIDE



Ratermann Part No.	Std. Pkg.	CGA-320 Nut Thread
CGA-320NUT-SS	10	.830"-14NGO-RH-INT.
<b>Std. Pkg. -10 NIPPLES &amp; WASHER</b>		
CGA-320NIPPLE-SS	1/4" NPT	2" Long
Co2-TWSEAL	PTFE Washer	

## CGA-326 3000 P.S.I.G.

### NITROUS OXIDE



Ratermann Part No.	Std. Pkg.	CGA-326 Nut Thread
CGA-326NUT-SS	10	.830"-14NGO-RH-INT.
<b>Std. Pkg. -10 NIPPLES</b>		
CGA-320NIPPLE-SS	1/4" NPT	2-1/2"

## CGA-330 3000 P.S.I.G.

### NON-CORROSIVE GASES



Ratermann Part No.	Std. Pkg.	CGA-330 Nut Thread
CGA-330NUT-SS	10	.830"-14NGO-LH-INT.
<b>Std. Pkg. -10 NIPPLES &amp; WASHER</b>		
CGA-330NIPPLE-SS	1/4" NPT	2" Long
Co2-TWSEAL	PTFE Washer	

## CGA-346 3000 P.S.I.G.

### AIR



Ratermann Part No.	Std. Pkg.	CGA-346 Nut Thread
CGA-346NUT-SS	10	.830"-14NGO-RH-INT.
<b>Std. Pkg. -10 NIPPLES</b>		
CGA-346NIPPLE-SS	1/4" NPT	2-1/2"

## CGA-347 Acetylene 250 P.S.I.G.

### AIR



Ratermann Part No.	Std. Pkg.	CGA-347 Nut Thread
CGA-347NUT-SS	10	.830"-14NGO-RH-INT.
<b>Std. Pkg. -10 NIPPLES</b>		
CGA-347NIPPLE-SS	1/4" NPT	3" Long

## CGA-350 3000 P.S.I.G.

### AIR



Ratermann Part No.	Std. Pkg.	CGA-350 Nut Thread
CGA-350NUT	20	.830"-14NGO-LH-INT.
<b>Std. Pkg. -10 NIPPLES</b>		
CGA-350NIPPLE-SS	1/4" NPT	2-1/2"

## CGA-510 Acetylene 250 P.S.I.G.

### Propane 500 P.S.I.G.

### ACETYLENE/PROPANE



Ratermann Part No.	Std. Pkg.	CGA-510 Nut Thread
CGA-510NUT-SS	20	.880"-14NGO-LH-EXT.
<b>Std. Pkg. -10 NIPPLES</b>		
CGA-510NIPPLE-SS	1/4" NPT	2-1/2"

## CGA-540 3000 P.S.I.G.

### OXYGEN



Ratermann Part No.	Std. Pkg.	CGA-540 Nut Thread
CGA-540NUT-SS	20	.908"-14NGO-RH-INT.
<b>Std. Pkg. -10 NIPPLES</b>		
CGA-540NIPPLE-SS	1/4" NPT	2-1/2"

## CGA-580 3000 P.S.I.G.

### INERT GASES



Ratermann Part No.	Std. Pkg.	CGA-580 Nut Thread
CGA-580NUT-SS	20	.960"-14NGO-RH-EXT.
<b>Std. Pkg. -10 NIPPLES</b>		
CGA-580NIPPLE3-SS	1/4" NPT	3"
CGA-580NIPPLE-SS	1/4" NPT	3-1/2"

## CGA-170 3000 P.S.I.G.



Ratermann Part No.	Std. Pkg.	CGA-170 Nut Thread
CGA-170NUT-SS	20	.5625"-18UNF-2B-RH-INT.
<b>Std. Pkg. -20 NIPPLES</b>		
CGA-170NIPPLE-SS	1/8" NPT	1-1/4"
CGA-170PTFEWASH-SS	PTFE Washer	

# CYLINDER CONNECTIONS: STAINLESS STEEL REGULATOR INLET NUTS & NIPPLES

## CGA-590

### INDUSTRIAL AIR



Ratermann Part No.	Std. Pkg.	CGA-590 Nut Thread
CGA-590NUT-SS	10	.960"-14NGO-LH-INT.
<b>Std. Pkg. -25 NIPPLES</b>		
CGA-590NIPPLESS	1/4" NPT	3"
CGA-580NIPPLESS	1/4" NPT	3-1/2" Long

## CGA-660

### REFRIGERANT GASES



Ratermann Part No.	Std. Pkg.	CGA-660 Nut Thread
CGA-660NUT-SS	10	1.035"-14NGO-RH-INT.
<b>Std. Pkg. -10 NIPPLES &amp; WASHERS</b>		
CGA-580NIPPLESS	1/4" NPT	3"
CGA-PTFEWASH		PTFE Washer

## CGA-677

### ARGON, NITROGEN & HELIUM



Ratermann Part No.	Std. Pkg.	CGA-677 Nut Thread
CGA-677NUT-SS	10	1.035"-14NGO-LH-INT.
<b>Std. Pkg. -10 NIPPLES &amp; WASHER</b>		
CGA-NIPPLETR		1/4" O.D. Tube Recess

## INLET NIPPLES & WASHERS

### INLET WASHERS

Ratermann Part No.	C.G.A. Inlet	Std. Pkg. Material
PH-320WF	320 and 330	100 Fiber
Co2-TWSEAL	320 and 330	100 PTFE
PH-320-W	320 and 330	100 PTFE
PH-660W	660	100 PTFE
PH-415WF	415	100 Fiber
PH-180W	180	50 PTFE

Most nipples are recessed for a filter if one needs to be installed.  
 Nipples can be supplied with a factory installed filter and retaining ring.  
 To order filters- add suffix "RF" plus the number of the filter desired to the part number.  
**For Example:** Oxygen nipple **PH-320WF** becomes **RFPH-320WF** when a sintered metal filter rated at 45 microns 3000 P.S.I.G. when installed at the factory.

### FILTERS FOR REGULATOR INLET NIPPLES

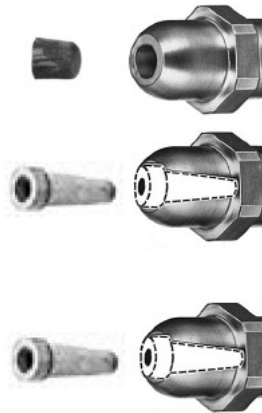

Ratermann Part No	When using filters, order nipples recessed for filter ("R" suffix)
FILTER-F4	FILTER SCREEN Stainless Steel, 100 Mesh, Rated at 140 Microns 7500 P.S.I.G.
FILTER-F6	Porous Metal Filter Sintered Bronze (Nickel Plated), Rated at 45 Microns 3000 P.S.I.G.
FILTER-F8	Porous Metal Filter Sintered Bronze (Nickel Plated), Rated at 35 Microns 6000 P.S.I.G.

## TYPE 316 STAINLESS STEEL MANIFOLD PIPELINE OUTLET ADAPTORS

### CGA VALVE OUTLET TO EXTERNAL PIPE THREAD



Ratermann Part No.	Std. Pkg.	Description
CGA-346SSMAN14RH	10	CGA-346 Air RH-EXT. to 1/4" NPT M 3000 P.S.I.G.
CGA-347SSMAN14RH	10	CGA-347 Air RH-EXT. to 1/4" NPT M 5500 P.S.I.G.
CGA-540SSMAN14RH	10	CGA-540 Oxygen RH-EXT. to 1/4" NPT M 3000 P.S.I.G.
CGA-677SSMAN14RH	10	CGA-677 Inert Gases* LH-EXT. to 1/4" NPT M 5501-7500 P.S.I.G.
CGA-677SSMAN12RH	10	CGA-677 Inert Gases* LH-EXT. to 1/2" NPT M 5501-7500 P.S.I.G.

### CGA VALVE OUTLET TO INTERNAL PIPE THREAD



Ratermann Part No.	Std. Pkg.	Description
CGA-346SSMAN14RHP	10	CGA-346 Air RH-EXT. to 1/4" NPT F 3000 P.S.I.G.
CGA-347SSMAN14RHP	10	CGA-347 Air RH-EXT. to 1/4" NPT F 3001-5500 P.S.I.G.
CGA-350SSMAN14RHP	10	CGA-350 Hydrogen/Methane LH-EXT. to 1/4" NPT F 3000 P.S.I.G.
CGA-540SSMAN14RHP	10	CGA-540 Oxygen RH-EXT. to 1/4" NPT F 3000 P.S.I.G.
CGA-580SSMAN14RHP	10	CGA-580 Inert Gases* RH-INT. to 1/4" NPT F 3000 P.S.I.G.
CGA-677SSMAN12RHP	10	CGA-677 Inert Gases* LH-EXT. to 1/2" NPT F 5501-7500 P.S.I.G.

## Rigid Stainless Steel Pigtails, Type 316 Stainless Steel Fittings with Type 304 Tubing

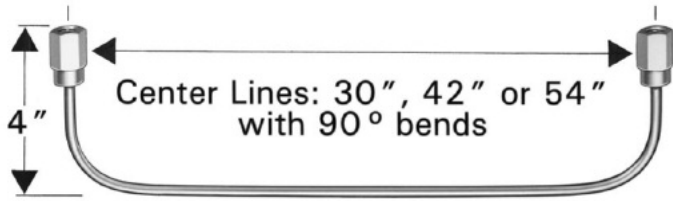

Part No. **PT-4I-36SS**

Furnished with 1/4" NPT Female fittings for installation of high pressure brass or stainless CGA connections, i.e. CGA 347, 577, 680, 701, etc.

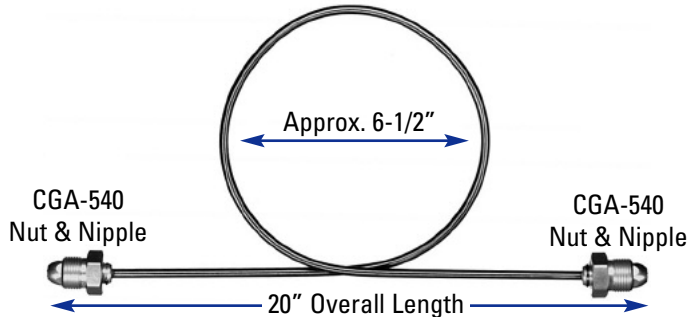

Part No. **PT-580-SS**

Part No.	Western Equivalent Part No.	Description Std. Pkg. 1
PT-041-36SS	PS-4-36	1/4" NPT Female 6500 P.S.I.G.
PT-041-48SS	PS-4-48	1/4" NPT Female 5500 P.S.I.G.

Part No.	Western Equivalent Part No.	Description Std. Pkg. 1
PT-041-60SS	PS-4-60	1/4" NPT Female 6500 P.S.I.G.
PTE-5C2SS	—	1/4" NPT Female Ends Only, 1/4" Tubing

Part No.	Western Equivalent Part No.	Description Std. Pkg. 1
PT-320SS	PS-320	CGA-320 Carbon Dioxide 3000 P.S.I.G.
PT-330SS	PS-330	CGA-330 Corrosive Gas 3000 P.S.I.G.
PT-346SS	PS-346	CGA-346 Air 3000 P.S.I.G.
PT-347SS	PS-347	CGA-347 Air 5500 P.S.I.G.
PT-350SS	PS-350	CGA-350 Hydrogen 3000 P.S.I.G.
PT-510SS	PS-510	Acetylene 250 P.S.I.G. Propane 500 P.S.I.G.

Part No.	Western Equivalent Part No.	Description Std. Pkg. 1
PT-540SS	PS-540	CGA-540 Oxygen 3000 P.S.I.G.
PT-580SS	PS-580	CGA-580 Inert Gases* 3000 P.S.I.G.
PT-590SS	PS-590	CGA-590 Industrial Air 3000 P.S.I.G.
PT-660SS	PS-660	CGA-660 Gas Mixtures 3000 P.S.I.G.
PT-677SS	PS-677	CGA-677 Inert Gases* 5501-7500 P.S.I.G.

## COUPLER TEES AND MANIFOLD BLOCKS

### BRASS MANIFOLD COUPLER TEES

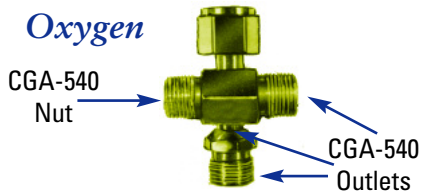

CGA-540  
Part No. **C-4540**

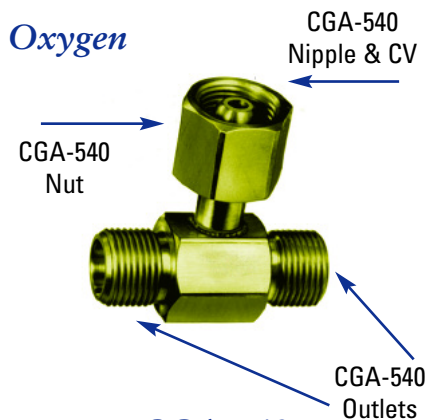

CGA-540  
Part No. **C-2540 CV**

Part No.	Western Equivalent Part No.	CGA No.	Coupler Tees with 3 CGA Valve Outlets, 1 CGA Nut & Nipple Std. Pkg.-1	Part No. With Nipple Check Valve*
C-4320	T4-320	320	Carbon Dioxide 3000 P.S.I.G.	C-4320CV
C-4346	T4-345	346	Air 3000 P.S.I.G.	C-4346CV
C-4510	T4-510	510	Acetylene 250 P.S.I.G. Propane 500 P.S.I.G.	C-4510CV
C-4540	T4-540	540	Oxygen 3000 P.S.I.G.	C-4540CV
C-4580	T4-580	580	Argon, Helium, Nitrogen 3000 P.S.I.G.	C-4580CV
C-4590	—	590	Industrial Air 3000 P.S.I.G.	C-4590CV

Part No.	Western Equivalent Part No.	CGA No.	Coupler Tees with 3 CGA Valve Outlets, 1 CGA Nut & Nipple Std. Pkg.-1	Part No. With Nipple Check Valve*
C-2296	T-296	296	Industrial Oxygen Mixtures 3000 P.S.I.G.	C-2296CV
C-2300	T-300	300	Acetylene 250 P.S.I.G.	C-2300CV
C-2320	T-320	320	Carbon Dioxide 3000 P.S.I.G.	C-2320CV
C-2326	T-326	326	Nitrous Oxide 3000 P.S.I.G.	C-2326CV
C-2346	T-346	346	Air 3000 P.S.I.G.	C-2346CV
C-2347	T-347	347	Air 5500 P.S.I.G.	C-2347CV
C-2350	T-82	350	Hydrogen, Methane, Natural Gas 3000 P.S.I.G.	C-2350CV
C-2510	T-15	510	Acetylene, Methane 250 P.S.I.G. Propane 500 P.S.I.G.	C-2510CV
C-2540	T-62	540	Oxygen 3000 P.S.I.G.	C-2540CV
C-2555	T-71	555	Butane, Propane, Liquid Withdrawl 3000 P.S.I.G.	
C-2577	—	540	Oxygen 4000 P.S.I.G.	
C-2580	T-92	580	Inert Gases 3000 P.S.I.G.	C-2580CV
C-2590	T-93	590	Sulfur Hexafluoride 3000 P.S.I.G.	C-2590CV
C-2660	—	660	Inert Gases 7500 P.S.I.G.	
C-2677	—	677	Inert Gases 7500 P.S.I.G.	
C-2680	T-680	680	Inert Gases 5500 P.S.I.G.	
C-2695	—	695	Flammables 5500 P.S.I.G.	
C-2701	—	701	Oxygen 5500 P.S.I.G.	
C-2702	—	702	Air 7500 P.S.I.G.	

\* See page **13B-21** for Check Valve information

## COUPLER TEES AND MANIFOLD BLOCKS

### BRASS MANIFOLD COUPLER TEES

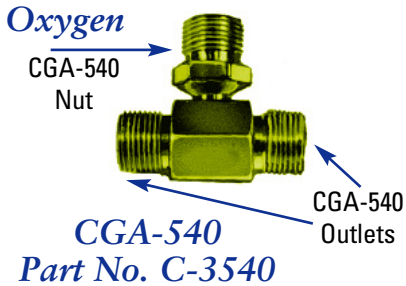

Part No.	Western Equivalent Part No.	CGA No.	Coupler Tees with 3 CGA Valve Outlets, 1 CGA Nut & Nipple	Std. Pkg.-1	Part No. With Nipple Check Valve*
C-3320	T3-320	320	Carbon Dioxide	3000 P.S.I.G.	C-4320CV
C-3326	T4-326	326	Nitrous Oxide	3000 P.S.I.G.	C-4346CV
C-3346	T3-346	346	Air	3000 P.S.I.G.	C-4510CV
C-3510	T3-510	510	Acetylene	250 P.S.I.G. Propane 500 P.S.I.G.	C-4540CV
C-3540	T3-540	540	Oxygen	3000 P.S.I.G.	C-4580CV
C-3580	T3-580	580	Argon, Helium, Nitrogen	3000 P.S.I.G.	C-4590CV

### STAINLESS STEEL MANIFOLD COUPLER TEES

Part No. C-2580SS



Part No.	Western Equivalent Part No.	CGA No.	Description	Std. Pkg.-1	Part No.	Western Equivalent Part No.	CGA No.	Description	Std. Pkg.-1
C-2320SS	T-CO-2SS	320	Carbon Dioxide	3000 P.S.I.G.	C-2540SS	T-62SS	540	Oxygen	3000 P.S.I.G.
C-2346SS	T-346SS	346	Air	3000 P.S.I.G.	C-2580SS	T-92SS	580	Inert Gases*	3000 P.S.I.G.
C-2347SS	T-3472SS	347	Air	3000 P.S.I.G.	C-2677SS		667	Inert Gases*	5001-7500 P.S.I.G.
C-2350SS	T-82SS	350	Hydrogen	3000 P.S.I.G.					* Nitrogen, Argon Helium

### BRASS & STAINLESS MANIFOLD BLOCKS & ACCESSORIES

Part No. MB-7



Part No.	Western Equivalent Part No.	2" Blocks with Female Ports	Std. Pkg. 1	Part No.	Western Equivalent Part No.	CGA No.	2" Hex Brass Blocks with 6 Valve Outlets, 1 CGA Nut & Nipple and 3 Plugs & Chains	Std. Pkg.-1	Part No. With Nipple Check Valve*
MB-6	MB-6	six 1/4" NPT Internal Outlets	3000 P.S.I.G.	MB-540-7	MB-50	540	Oxygen	3000 P.S.I.G.	MB540-7CV
MB-6SS	MB-6SS	six 1/4" NPT Internal Outlets	6000 P.S.I.G.	MB-580-7	MB-70	580	Argon, Helium, Nitrogen	3000 P.S.I.G.	MB580-7CV
MB-7	MB-7	seven 1/4" NPT Internal Outlets	3000 P.S.I.G.						
MB-7SS	MB-7SS	seven 1/4" NPT Internal Outlets	6000 P.S.I.G.						

### BRASS NIPPLE CHECK VALVES, PIGTAIL TUBING, PIGTAILS WITH NPT ENDS

#### BRASS CHECK VALVES FOR PIGTAIL NIPPLES

These Brass Check Valves are factory tested and installed in CGA Nipples for additional safety in Pigtails, etc. to prevent dangerous reverse flow of gases in lines and other compressed gas equipment.

**NOTE:** These check valves protect against reverse flow only and are not flash arrestors.

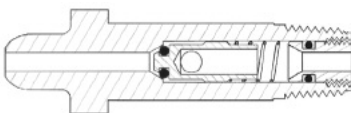

FLOW

Part No. NP-210CV

Also Available With the Check Valve reversed Specify "RCV"

Part No.	Western Equivalent Part No.	CGA No.	Description	Std. Pkg. 1
NP-123CV	29-3CV	296	1/4" NPT x 3" Long - Industrial Oxygen Mixtures	3000 P.S.I.G.
NP-128CV	16-8CV	300	1/4" NPT x 2-1/2" Long - Acetylene	250 P.S.I.G.
NP-733CV	13-3CV	326	1/4" NPT x 2-1/2" Long - Nitrous Oxide	3000 P.S.I.G.
NP-753CV	14-3CV	346	1/4" NPT x 2-1/2" Long - Air	3000 P.S.I.G.
NP-168CV	83-CV	350	1/4" NPT x 2-1/2" Long - Hydrogen, Methane	3000 P.S.I.G.
NP-188CV	15-8CV	500	1/4" NPT x 2-1/2" Long - Medical Mixtures	3000 P.S.I.G.
NP-188CV	15-8CV	510	1/4" NPT x 2-1/2" Long - Acetylene 1/4" NPT x 2-1/2" Long - Propane	250 P.S.I.G. 500 P.S.I.G.
NP-189CV	15-3CV	510	1/4" NPT x 3" Long - Acetylene 1/4" NPT x 3" Long - Propane	250 P.S.I.G. 500 P.S.I.G.
NP-210CV	63-CV	540	1/4" NPT x 2-1/2" Long - Oxygen	3000 P.S.I.G.
NP-188CV	15-8CV	580	1/4" NPT x 2-1/2" Long - Argon, Helium, Nitrogen	3000 P.S.I.G.
NP-188CV	15-8CV	590	1/4" NPT x 2-1/2" Long - Industrial Air	3000 P.S.I.G.
NP-128WRCV	—	300	1/4" NPT x 2-1/2" Long - Acetylene, O-Ring soft tip	250 P.S.I.G.
NP-436WRCV	—	520	1/4" NPT x 2-1/2" Long - Acetylene, O-Ring soft tip	250 P.S.I.G.

# HAND TIGHT MANIFOLD ASSEMBLY PARTS

## BRASS & PLASTIC GRIPS



**PART NO. BH-540NUT**  
All Brass

**PART NO. PH-540NIPPLE**  
Soft Tip



**PART NO. PH-540-NR**  
Soft Tip Replacement



**PART NO. PH-580NUT**  
Brass with Plastic Grip



**PART NO. CGA-580NIPPLECF**  
"O" Ring Nipple



**PART NO. PH-347NUTSS**  
SS w/Aluminum Handle

**Ratermann**

Part No.	Std. Pkg.	Description
<b>CGA-296 SERIES INDUSTRIAL OXYGEN MIXTURES 3000 P.S.I.G.</b>		
PH-296NUTB	10	Hand Nut-CGA-296 R.H. External-All Brass
PH-296NIPPLE3	25	Nipple, CGA-296 -1/4" NPT-3" Long
PH-296-OR	25	Replacement "O" Rings
<b>CGA-300 SERIES ACETYLENE 250 P.S.I.G.</b>		
PH-300NUTB	10	Hand Nut-CGA-300 R.H. Internal-All Brass
PH-300NUTIPG	10	Hand Nut-CGA-300 R.H. Internal-Plastic Grip
PH-300NIPPLE	25	Nipple, CGA-300 -1/4" NPT-2-1/2" Long
PH-300-W	25	Replaceable PTFE Washer
<b>CGA-320 SERIES CARBON DIOXIDE 3000 P.S.I.G.</b>		
BH-320NUT	10	Hand Nut-CGA-320 R.H. Internal-All Brass
PH-320NUT	10	Hand Nut-CGA-320 R.H. Internal-Plastic Grip
BH-320NIPPLE	25	Nipple, CGA-320 -1/4" NPT-2-1/2" Long
PH-NIPPLE14	25	Nipple Countersunk for 1/4" Tube
PH-320-W	100	CGA-320 PTFE Washer
<b>CGA-326 SERIES NITROUS OXIDE 3000 P.S.I.G.</b>		
BH-326NUT	10	Hand Nut-CGA-326 R.H. Internal-All Brass
PH-326NUTIPG	10	Hand Nut-CGA-326 R.H. Internal-Plastic Grip
PH-326NIPPLE	25	Nipple, CGA-326 -1/4" NPT-2-1/2" Long
PH-NIPPLE516	25	Nipple Countersunk for 5/16" Tube
PH-326-NR	25	Replaceable CTFE Nipple Tip
<b>CGA-346 SERIES AIR 3000 P.S.I.G.</b>		
BH-346NUT	10	Hand Nut-CGA-346 R.H. Internal-All Brass
PH-346NUTIPG	10	Hand Nut-CGA-346 R.H. Internal-Plastic Grip
BH-346NIPPLE	25	Nipple, CGA-346 -1/4" NPT-2-1/2" Long
PH-346-NR	25	Replaceable CTFE Nipple Tip
<b>CGA-347 SERIES AIR 3000-5000 P.S.I.G.</b>		
PH-347NUT**	10	Hand Nut-CGA-347 R.H. Internal
PH-347NUTIPG	10	Hand Nut-CGA 347 RH Internal Plastic Grip
PH-347NIPPLE3**	25	Nipple CGA-347-1/4" NPT-3"
PH-347-OR	25	Replacement "O" Ring for NP-765W Nipple
<b>CGA-350 SERIES HYDROGEN, METHANE 3000 P.S.I.G.</b>		
P-320NUTB	10	Hand Nut-CGA-320 R.H. Internal-All Brass
PH-350NIPPLE	25	Nipple, CGA-350 -1/4" NPT-2-1/2" Long
PH-NIPPLE14	25	Nipple Countersunk for 1/4" Tube
PH-350-NR	25	Replaceable PTFE Nipple Tip
<b>CGA-500 SERIES MEDICAL MIXTURES 3000 P.S.I.G.</b>		
PH-500NUTEPG	10	Hand Nut-CGA-500 R.H. External-Plastic Grip
PH-580NIPPLE	25	Nipple, CGA-500 -1/4" NPT-3-1/2" Long
PH-580NOR	25	With "O" Ring, CGA-500 -1/4" NPT-3-1/2" Long
PH-580-OR	25	Replacement "O" Rings for NP190W Nipples
PH-NIPPLE14	25	Nipple Countersunk for 1/4" Tube

Part No.	Std. Pkg.	Description
<b>CGA-510 SERIES ACETYLENE 250 P.S.I.G. PROPANE 500 P.S.I.G.</b>		
CGA-510HT	10	Hand Nut-CGA-510 L.H. External-All Brass
PH-510NUTEPG	10	Hand Nut-CGA-510 L.H. External-Plastic Grip
PH-510NIPPLE*	25	Nipple, CGA-510 -1/4" NPT-3" Long
PH-580NIPPLE312	25	Nipple, CGA-510 -1/4" NPT-3-1/2" Long
PH-580NOR	25	Nipple with "O" Ring, GCA-510-1/4"NPT-3-1/2" Long
PH-NIPPLE14	25	Nipple Countersunk for 1/4" Tube
PH-580-OR	25	Replacement "O" Rings for NP190W Nipples
PH-580-NR	25	Replaceable PTFE Nipple Tip
<b>CGA-540 SERIES OXYGEN 3000 P.S.I.G.</b>		
BH-540NUT	10	Hand Nut-CGA-540 R.H. Internal-All Brass
PH-540NUT	10	Hand Nut-CGA-540 R.H. Internal-Plastic Grip
PH-540NIPPLE	25	Nipple, CGA-540 -1/4" NPT-2-1/2" Long
PH-540NOR	25	Nipple with "O" Ring, GCA-540-1/4" NPT-3-1/2" Long
PH-NIPPLE14	25	Nipple Countersunk for 1/4" Tube
PH-540-NR	25	Replaceable Nipple Tip
<b>CGA-555 SERIES PROPANE (LIQUID WITHDRAWAL) 3000 P.S.I.G.</b>		
PH-555NUTB	10	Hand Nut-CGA-55 L.H. Internal-All Brass
PH-540NIPPLE	25	Nipple, CGA-555 -1/4" NPT-2-1/2" Long
PH-NIPPLE14	25	Nipple Countersunk for 1/4" Tube
PH-NIPPLE516	25	Nipple Countersunk for 5/16" Tube
PH-540-NR	25	Replaceable Nipple Tip
<b>CGA-580 SERIES ARGON, HELIUM, NITROGEN 3000 P.S.I.G.</b>		
BH-580NUT	10	Hand Nut-CGA-580 R.H. External-All Brass
PH-580NUT	10	Hand Nut-CGA-580 R.H. Internal-Plastic Grip
PH-580NIPPLE*	25	Nipple, CGA-580 -1/4" NPT-3" Long
PH-580NIPPLE312	25	Nipple, CGA-580 -1/4" NPT-3-1/2" Long
PH-580NOR	25	Nipple with "O" Ring, CGA-580-1/4" NPT-3-1/2" Long
PH-580-OR	25	Replacement "O" Rings for NP190W Nipples
PH-NIPPLE14	25	Nipple Countersunk for 1/4" Tube
PH-580-NR	25	Replaceable PTFE Nipple Tip
<b>CGA-590 SERIES INDUSTRIAL AIR 3000 P.S.I.G.</b>		
PH-590NUTB	10	Hand Nut-CGA-590 R.H. External-All Brass
PH-580NIPPLE*	25	Nipple, CGA-580 -1/4" NPT-3" Long
PH-580NIPPLE312	25	Nipple, CGA-580 -1/4" NPT-3-1/2" Long
PH-580NOR	25	Nipple with "O" Ring, CGA-580-1/4" NPT-3-1/2" Long
PH-580-OR	25	Replacement "O" Rings for NP190W Nipples
PH-580NIPPLE14	25	Nipple Countersunk for 1/4" Tube
PH-580-NR	25	Replaceable PTFE Nipple Tip

Nipples are Supplied with Replaceable Soft Tips or "O" Rings  
 \* **Do not use with Plastic Grip Handtight Nuts**  
 \*\* **Also available in Stainless Steel Handtight**

**BRASS "Y" CONNECTORS    MAXIMUM PRESSURE 200 P.S.I.G.**

**"Y" CONNECTORS WITH BALL SEAT SHUT-OFF VALVES**

*New Ergonomic Design!*



*Part No. YV-50*



*Part No. YV-420*

Part No.	Western Equivalent Part No.	Std. Pkg.	Service	Inlet	Description	Outlets
YV-50	111	10	Oxygen	"B" 9/16" -18-RH - Internal Swivel Nut	"B" 9/16" -18-RH - External	"B" 9/16" -18-RH - External
YV-51	112	10	Fuel Gas	"B" 9/16" -18-LH - Internal Swivel Nut	"B" 9/16" -18-LH - External	"B" 9/16" -18-LH - External
YV-420	411	1	Argon	5/8" -18-RH - External Swivel Nut "B"	5/8" -RH - Internal "B"	5/8" -RH - Internal "B"
YV-421	412	1	Air-Water	5/8" -18-LH - External Swivel Nut "B"	5/8" -LH - Internal "B"	5/8" -LH - Internal "B"

**"Y" CONNECTORS WITHOUT VALVES**



*Part No. Y-80*

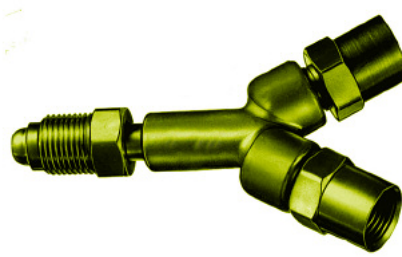

*Part No. Y-420*

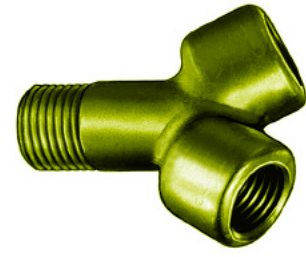

*Part No. Y-224*

Part No.	Western Equivalent Part No.	Std. Pkg.	Service	Inlet	Description	Outlets
Y-50	101	10	Oxygen	"B" 9/16" -18-RH - Internal Swivel Nut	"B" 9/16" -18-RH - External	"B" 9/16" -18-RH - External
Y-51	102	10	Fuel Gas	"B" 9/16" -18-LH - Internal Swivel Nut	"B" 9/16" -18-LH - External	"B" 9/16" -18-LH - External
Y-80	111-7	10	Oxygen	"B" 9/16" -18-RH - Internal Swivel Nut	"B" 9/16" -18-RH - External	1/4" NPT - Female
Y-81	—	10	Fuel Gas	"B" 9/16" -18-LH - Internal Swivel Nut	"B" 9/16" -18-LH - External	1/4" NPT - Female
Y-420	401	1	Argon	5/8" -18-RH - External Swivel Nut "B"	5/8" -18-RH - Internal "B"	5/8" -18-RH - Internal "B"
Y-421	402	1	Air-Water	5/8" -18-LH - External Swivel Nut "B"	5/8" -18-LH - Internal "B"	5/8" -18-LH - Internal "B"

**"Y" CONNECTORS WITHOUT PIPE THREADS**

**3000 P.S.I.G.**

Part No.	Western Equivalent Part No.	Std. Pkg.	Service	Inlet	Description	Outlets
Y-184	111-6	10	All Non-Corrosive Gases	1/8" NPT - Female	1/8" NPT - Female	1/4" NPT - Female
Y-224	111-5	10	All Non-Corrosive Gases	1/4" NPT - Male	1/4" NPT - Male	1/4" NPT - Male

# BRASS SHUT-OFF VALVES AND DUST CAPS

## BALL SEAT SHUT-OFF VALVES



Part No. V-88

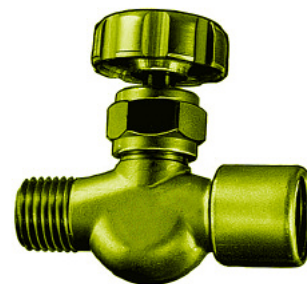

Part No. V-454

Part No.	Western Equivalent Part No.	Std. Pkg.	Service	Inlet Description	Outlet Description	Maximum Pressure
V-25	—	10	Fuel Gas	"A" 3/8"-24-LH-External	1/8" NPT-Male	200 P.S.I.G.
V-50	209	10	Oxygen	"B" 9/16"-18-RH-External	"B" 9/16"-18-RH-External	200 P.S.I.G.
V-51	210	10	Fuel Gas	"B" 9/16"-18-LH-External	"B" 9/16"-18-LH-External	200 P.S.I.G.
V-52	203	10	Oxygen	"B" 9/16"-18-RH-Internal Swivel Nut	"B" 9/16"-18-RH-External	200 P.S.I.G.
V-53	204	10	Fuel Gas	"B" 9/16"-18-LH-Internal Swivel Nut	"B" 9/16"-18-LH-External	200 P.S.I.G.
V-69	—	10	Fuel Gas	"B" 9/16"-18-LH-External	1/8" NPT-Male	200 P.S.I.G.
V-76	207	10	Oxygen	"B" 9/16"-18-RH-External	1/4" NPT-Male	200 P.S.I.G.
V-77	208	10	Fuel Gas	"B" 9/16"-18-LH-External	1/4" NPT-Male	200 P.S.I.G.
V-81	208-F	10	Fuel Gas	"B" 9/16"-18-LH-External	1/4" NPT-Female	200 P.S.I.G.
V-88	205	10	Oxygen	1/4" NPT - Male	"B" 9/16"-18-RH-External	200 P.S.I.G.
V-89	206	10	Fuel Gas	1/4" NPT - Male	"B" 9/16"-18-LH-External	200 P.S.I.G.
V-420	215-FR	10	Argon	5/8"-18-RH-External Swivel Nut "B"	5/8"-18-RH-Internal "B"	200 P.S.I.G.
V-454	215-AR	10	Argon	1/4" NPT - Male	5/8"-18-RH-Internal "B"	200 P.S.I.G.

Part No.	Western Equivalent Part No.	Std. Pkg.	Service	Inlet Description	Outlet Description	Maximum Pressure
V-301	211-E	10	All Gases*	1/8" NPT - Male	1/8" NPT-Male	3000 P.S.I.G.
V-332	218-D	10	All Gases*	1/4" NPT - Female	1/4" NPT - Female	3000 P.S.I.G.
V-333	211	10	All Gases*	1/4" NPT - Male	1/4" NPT - Male	3000 P.S.I.G.
V-334	218	10	All Gases*	1/4" NPT - Female	1/4" NPT - Male	3000 P.S.I.G.
V-335	217	10	All Gases*	1/4" NPT - Male	1/4" NPT - Female	3000 P.S.I.G.

\*Non-Corrosive Gases

## DUST CAP & CHAIN ASSEMBLIES

Dust caps are one piece blind nuts used to protect threads and keep contamination from cylinder valves. CGA thread specifications are used, but **they do not make a gas tight seal.**



Part No. CGA-540DC  
Oxygen

Ratermann Part No.	CGA No.	Description
CGA-020DC	022	Oxygen Std. "B" Hose Size 9/16"-18 RH-Internal
CGA-021DC	023	Fuel Gas Std. "B" Hose Size 9/16"-18 LH-Internal
CGA-034DC	024	Oxygen "C" Hose Size 7/8"-14 RH-Internal
CGA-035DC	025	Fuel Gas "C" Hose Size 7/8"-14 LH-Internal
CGA-300DC	300	Acetylene - RH-Internal
CGA-320DC	320	Carbon Dioxide - RH-Internal
CGA-346DC	346	Air - RH-Internal
CGA-350DC	350	Hydrogen, Methane - LH-Internal
CGA-510DC	510	Acetylene, Propane - LH-External
CGA-540DC	540	Oxygen - RH-Internal
CGA-555DC	555	Propane Liquid Withdrawal - LH-External
CGA-580DC	580	Argon, Helium, Nitrogen - RH-Internal
CGA-660DC	660	Refrigeration Gases - RH-Internal

# BRASS PLUG & CHAIN ASSEMBLIES FOR SEALING MANIFOLDS, CYLINDERS & HOSE CONNECTORS

## TWO-PIECE PLUG AND CHAIN ASSEMBLIES

These two-piece nut and blind nipple assemblies made to CGA and IAA standards make a gas tight seal with a standard CGA connections. Also available with replaceable soft tips or "O" rings.



Part No. *FIT-2PC-540*



Part No. *FIT-2PC-510*

Ratermann Part No.	CGA No.	Description	Gas Tight Seal
FIT-2PC-021	021	Fuel Gas "A" Hose Size 3/8"-24-LH-Internal	200 P.S.I.G.
FIT-2PC-022	022	Oxygen Std. "B" Hose Size 9/16"-18-RH-Internal	200 P.S.I.G.
FIT-2PC-023	023	Fuel Gas Std. "B" Hose Size 9/16"-18-LH-Internal	200 P.S.I.G.
FIT-2PC-024	024	Oxygen "C" Hose Size 7/8"-14-RH-Internal	200 P.S.I.G.
FIT-2PC-025	025	Fuel Gas "C" Hose Size 7/8"-14-LH-Internal	200 P.S.I.G.
FIT-2PC-026	026	Oxygen "D" Hose Size 1-1/4"-12-RH-Internal	200 P.S.I.G.
FIT-2PC-027	027	Fuel Gas "D" Hose Size 1-1/4"-12-LH-Internal	200 P.S.I.G.
FIT-2PC-032EXT	032	Inert Gas "B" Hose Size 5/8"-18-RH-External	200 P.S.I.G.
FIT-2PC-033	033	Air-Water "B" Hose Size 5/8"-18-LH-External	200 P.S.I.G.
FIT-2PC-032INT	032	Inert Gas "B" Hose Size 5/8"-18-RH-Internal	200 P.S.I.G.
FIT-2PC-034	034	Inert Gas "C" Hose Size 7/8"-14-RH-External	200 P.S.I.G.
FIT-2PC-326	326	Nitrous Oxide-RH-Internal	3000 P.S.I.G.
FIT-2PC-346	346	Air-RH-Internal	3000 P.S.I.G.
FIT-2PC-347	347	Air-RH-Internal Type 316	3001-5500 P.S.I.G.
FIT-2PC-347SS	347	Air-RH-Internal Type 316 Stainless Steel	3001-5500 P.S.I.G.
FIT-2PC-350	350	Hydrogen, Methane-LH-Internal	3000 P.S.I.G.
FIT-2PC-510	510	Acetylene-LH-External Propane-LH-External	250 P.S.I.G. 500 P.S.I.G.
FIT-2PC-520	520	"B" Acetylene-RH-Internal	250 P.S.I.G.
FIT-2PC-540	540	Oxygen-RH-Internal	3000 P.S.I.G.
FIT-2PC-555	555	Propane (Liquid Withdrawal)-LH-Internal	3000 P.S.I.G.
FIT-2PC-580	580	Argon, Helium, Nitrogen-RH-External	3000 P.S.I.G.

## ONE-PIECE PLUG AND CHAIN ASSEMBLIES

These shorter one-piece plug and chains can be used, where space is limited, to seal-off cylinder valves and still be able to install the cylinder valve cap. These nipples have replaceable soft tips or "O" rings for a more positive seal using less force.



Part No. *FIT-OPC-540*  
Oxygen



Part No. *FIT-OPC-580*  
Argon, Helium, Nitrogen

Ratermann Part No.	CGA No.	Description	Gas Tight Seal
FIT-OPC-320	320	Carbon Dioxide-RH-Internal	3000 P.S.I.G.
FIT-OPC-326	326	Nitrous Oxide-RH-Internal	3000 P.S.I.G.
FIT-OPC-330	330	Non-Corrosive Gas-LH-Internal	3000 P.S.I.G.
FIT-OPC-346	346	Air-RH-Internal	3000 P.S.I.G.
FIT-OPC-350	350	Hydrogen, Methane-LH-Internal	3000 P.S.I.G.
FIT-OPC-510	510	Acetylene-LH-External Propane-LH-External	250 P.S.I.G. 500 P.S.I.G.
FIT-OPC-540	540	Oxygen-RH-Internal	3000 P.S.I.G.
FIT-OPC-555	555	Propane (Liquid Withdrawal)-LH-Internal	3000 P.S.I.G.
FIT-OPC-580	580	Argon, Helium, Nitrogen-RH-External	3000 P.S.I.G.
FIT-OPC-590	590	Industrial Air-LH-External	3000 P.S.I.G.

# ALL PURPOSE AIR/PROPANE TORCH KIT



500,000 BTU's  
U.L. listed

Brass Control knob

All steel handle &  
head construction

Includes:

- Torch
- 10' hose with POL safety valve & CGA 510 L.P. connection
- Flint striker

- ◆ Thaw Pipes
- ◆ Paint Removal
- ◆ Asphalt Repair
- ◆ Clear Brush/Weeds

FOR USE ON FARMS,  
CONSTRUCTION, ROOFING,  
HOME, FACTORIES  
ANYWHERE!

Part No. PHT-101

## BRASS AND COPPER PIGTAIL ASSEMBLIES

### RIGID PIGTAIL ASSEMBLIES

Part No. PT-540



Approximate 12" Overall Length

Oxygen CGA-540 TO 540

Pigtails are assembled with 5/16" O.D. x .065 wall annealed copper or brass tubing silver brazed to brass fittings of CGA specifications. Nuts are held in place with snap rings.

Brass tubing is required for use with acetylene

Part No. PT-510

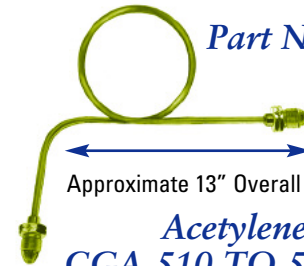

Approximate 13" Overall Length

Acetylene  
CGA-510 TO 510-90°

Part No.	Western Equivalent Part No.	CGA No.	Std. Pkg.	Service	Pigtail with CGA Fittings	Tubing	Part No. With Nipple Check Valve
PT-300	P-16	300	1	Acetylene-RH-Internal 250 P.S.I.G.			Brass PT-300CV
PT-320	P-CO-3	320	1	Carbon Dioxide-RH-Internal 3000 P.S.I.G.		Copper	PT-320CV
PT-326	P-1320	326	1	Nitrous Oxide-RH-Internal 3000 P.S.I.G.		Copper	PT-326CV
PT-346	P-1340	346	1	Air-RH-Internal 3000 P.S.I.G.		Copper	PT-346CV
PT-510	—	510-90°	1	Acetylene-LH-External 250 P.S.I.G.		Brass	PT-510CV
PT-510S	—	510	1	Propane-LH-External 500 P.S.I.G.		Copper	PT-510CV
PT-540	P-63	540	1	Oxygen-RH-Internal 3000 P.S.I.G.		Copper	PT-540CV
PT-580	P-92	580	1	Argon, Helium, Nitrogen-RH-External 3000 P.S.I.G.		Copper	PT-580CV

### SNAP RINGS FOR PIGTAILS

Part No.	Western Equivalent Part No.	Std. Pkg.	Description
XSR-020	—	25	Snap Rings — Secures CGA Nuts

### SNAP RINGS FOR PIGTAILS

Part No.	Western Equivalent Part No.	50 Foot Coils	3000 P.S.I.G.
CT-44	CT-40	1/4" O.D. Tubing x .065 wall	
CT-45	CT-50	5/16" O.D. Tubing x .065 wall	
CT-45	CT-60	3/8" O.D. Tubing x .065 wall	

### NPT ENDS FOR COPPER OR BRASS TUBING

Part No.	Western Equivalent Part No.	Std. Pkg.	Description	3000 P.S.I.G.
XPTE-004C2	—	10	Extender - Male 1/4" NPT Brass for 1/2" O.D. Tubing	
XPTE-004C3	—	10	Extender - Male 3/8" NPT Brass for 3/4" O.D. Tubing	
XPTE-005C2	BT-2M1	10	Extender - Female 1/4" NPT Brass for 1/2" O.D. Tubing	
XPTE-005C2SS	BT-2M1-SS	10	Extender - Female 1/4" NPT Stainless Steel for 1/2" O.D. Tubing	
XPTE-005C3	BT-2M2	10	Extender - Female 3/8" NPT Brass for 3/4" O.D. Tubing	

# BRASS AND COPPER PIGTAIL ASSEMBLIES

## RIGID PIGTAIL ASSEMBLIES WITH SINGLE 6-1/2" LOOP (Approximately 20" Overall Length)



*PTH-4540*

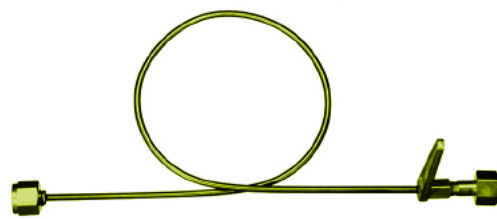

*PTW-4320*

CGA No.	Operating Pressure	Standard Pigtail	Plastic H.T. Nut-One End	Brass Handle-One End	S.S. Tube & S.S. Ends	S.S. Tube & Brass Ends
300	250 psig	PT-3300	PTH-3300	PTW-3300	N/A	PT-2300
320	3000 psig	PT-4320	PTH-4320	PTW-4320	PT-320SS	PT-2320
326	3000 psig	PT-4326	PTH-4326	PTW-4326	PT-326SS	PT-2326
346	3000 psig	PT-4346	PTH-4346	PTW-4346	PT-346SS	PT-2346
350	3000 psig	PT-4350	PTH-4350	PTW-4350	PT-350SS	PT-2350
510	500 psig	PT-4510	PTH-4510	PTW-4510	PT-510SS	PT-2510
510-90°	250 psig	PT-3510	PTH-3510	PTW-3510	N/A	N/A
540	3000 psig	PT-4540	PTH-4540	PTW-4540	PT-540SS	PT-2540
580	3000 psig	PT-4580	PTH-4580	PTW-4580	PT-580SS	PT-2580
590	3000 psig	PT-4590	PTH-4590	PTW-4590	PT-590SS	PT-2590

## RIGID STAINLESS STEEL FILL PLANT LEADS

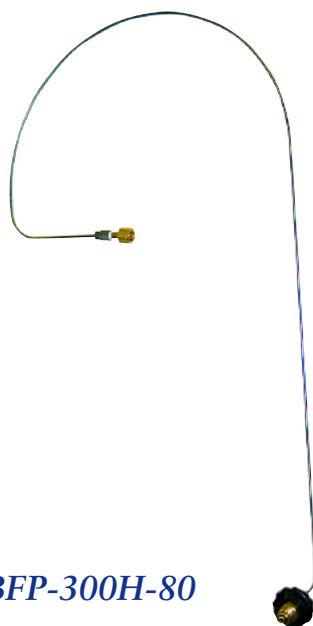

*BFP-300H-80*

These fill leads offer an alternative to flexible pigtails in your fill plant. They offer extra long service life and are a good choice for filling high purity cylinders. The stainless steel tubing & end fittings allow for zero diffusion of air, moisture or hydrocarbons maintaining the integrity of high purity gases.

- Tig welded end connections
- Replaceable CGA ends
- Stainless steel tube & fittings
- Other CGA/gas services available

Gas Service	CGA	BFP Series
Commercial Acetylene	CGA 300	BFP-300H-80
Carbon Dioxide	CGA 320	BFP-320H-80
Nitrous Oxide	CGA 326	BFP-326H-80
Air	CGA 346	BFP-346H-80
Air (6000 PSI)	CGA 347	BFP-347H-80
Hydrogen	CGA 350	BFP-350H-80
Propane / Acetylene	CGA 510	BFP-510H-80
Oxygen	CGA 540	BFP-540H-80
Inert Gases	CGA 580	BFP-580H-80

# BRASS MANIFOLD PIPELINE OUTLET ADAPTORS

## GAS CYLINDER VALVE OUTLET SERIES TO MALE PIPE THREAD

### NON-CORROSIVE GAS OUTLET 3000 P.S.I.G.

**CGA-180**  
*Small Cylinders*



Ratermann Part No.	Std. Pkg.	CGA-180 .620" 18UNF-2B RH-External
CGA-18014	10	CGA-180 to 1/4" NPT

### ACETYLENE OUTLET 250 P.S.I.G.

**CGA-300**



Ratermann Part No.	Std. Pkg.	CGA-300 .825" 14NGO RH-External
CGA-30014	10	CGA-300 to 1/4" NPT
CGA-30012	10	CGA-300 to 1/2" NPT

### CARBON DIOXIDE OUTLET 3000 P.S.I.G.

**CGA-320**



Ratermann Part No.	Std. Pkg.	CGA-320 .825" 14NGO RH-External
CGA-32014	10	CGA-320 to 1/4" NPT
CGA-32038	10	CGA-320 to 3/8" NPT
CGA-32012	10	CGA-320 to 1/2" NPT

### NITROUS OXIDE OUTLET 3000 P.S.I.G.

**CGA-326**



Ratermann Part No.	Std. Pkg.	CGA-326 .825" 14NGO RH-External
CGA-32614	10	CGA-320 to 1/4" NPT
CGA-32638	10	CGA-320 to 3/8" NPT
CGA-32612	10	CGA-320 to 1/2" NPT

### AIR OUTLET 3000 P.S.I.G.

**CGA-346**



Ratermann Part No.	Std. Pkg.	CGA-346 .825" 14NGO RH-External
CGA-34614	10	CGA-320 to 1/4" NPT
CGA-34612	10	CGA-320 to 1/2" NPT

### HYDROGEN, METHANE OUTLET 3000 P.S.I.G.

**CGA-350**



Ratermann Part No.	Std. Pkg.	CGA-350 .825" 14NGO LH-External
CGA-35014	10	CGA-350 to 1/4" NPT
CGA-35012	10	CGA-350 to 1/2" NPT

### MEDICAL MIXTURES OUTLET 3000 P.S.I.G.

**CGA-500**



Ratermann Part No.	Std. Pkg.	CGA-500 .885" 14NGO RH-Internal
CGA-50014	10	CGA-500 to 1/4" NPT

### ACETYLENE OUTLET 250 P.S.I.G. PROPANE OUTLET 500 P.S.I.G.

**CGA-510**



Ratermann Part No.	Std. Pkg.	CGA-510 .885" 14NGO LH-Internal
CGA-51014	10	CGA-300 to 1/4" NPT
CGA-51012	10	CGA-300 to 1/2" NPT

### OXYGEN OUTLET 3000 P.S.I.G.

**CGA-540**



Ratermann Part No.	Std. Pkg.	CGA-540 .903" 14NGO RH-External
CGA-54014	10	CGA-540 to 1/4" NPT
CGA-54038	10	CGA-540 to 3/8" NPT
CGA-54012	10	CGA-540 to 1/2" NPT

### PROPANE (Liquid Withdrawal) OUTLET 3000 P.S.I.G.

**CGA-555**



Ratermann Part No.	Std. Pkg.	CGA-555 .903" 14NGO LH-External
CGA-55512	10	CGA-555 to 1/2" NPT

### ARGON, HELIUM, NITROGEN OUTLET 3000 P.S.I.G.

**CGA-580**



Ratermann Part No.	Std. Pkg.	CGA-580 .965" 14NGO RH-External
CGA-58014	10	CGA-580 to 1/4" NPT
CGA-58038	10	CGA-580 to 3/8" NPT
CGA-58012	10	CGA-580 to 1/2" NPT
CGA-58034	10	CGA-580 to 3/4" NPT

### INDUSTRIAL AIR OUTLET 3000 P.S.I.G.

**CGA-590**



Ratermann Part No.	Std. Pkg.	CGA-555 .903" 14NGO LH-External
CGA-59014	10	CGA-590 to 1/4" NPT

# HIGH PRESSURE BRASS MANIFOLD OUTLET ADAPTORS

## CGA CYLINDER VALVE OUTLET ADAPTORS TO NPT THREAD

### AIR OUTLET 3001-5500 P.S.I.G.

CGA-347



Ratermann Part No.	Std. Pkg.	Brass CGA-347 .825" 14NGO RH-External
CGA-34714	10	CGA-347 to 1/4" NPT male
CGA-34712	10	CGA-347 to 1/2" NPT male

### ARGON, HELIUM, NITROGEN 3001-5500 P.S.I.G.

CGA-680



Ratermann Part No.	Std. Pkg.	Brass CGA-680 1.045" 14NGO RH-Internal
CGA-68012	10	CGA-680 to 1/2" NPT male

### OXYGEN OUTLET 3001-4000 P.S.I.G.

CGA-577



Ratermann Part No.	Std. Pkg.	Brass CGA-577 .960" 14NGO RH-External
CGA-57712	10	CGA-577 to 1/2" NPT male

### OXYGEN OUTLET 4001-5500 P.S.I.G.

CGA-701



Ratermann Part No.	Std. Pkg.	Brass CGA-701 1.103" 18NGO RH-External
CGA-70112	10	CGA-701 to 1/2" NPT male

### ARGON, HELIUM, NITROGEN 5501-7500 P.S.I.G.

CGA-677



Ratermann Part No.	Std. Pkg.	Brass CGA-677 1.030" 14NGO LH-External
CGA-67714	10	CGA-677 to 1/4" NPT male
CGA-67712	10	CGA-677 to 1/2" NPT male

### AIR OUTLET 5501-7500 P.S.I.G.

CGA-702



Ratermann Part No.	Std. Pkg.	Brass CGA-702 1.125" 14NGO RH-Internal
CGA-70212	10	CGA-702 to 1/2" NPT male

# BRASS & BRASS CHROME PLATED ADAPTOR NUTS

## CGA VALVE OUTLET ADAPTORS TO FEMALE NPT THREAD

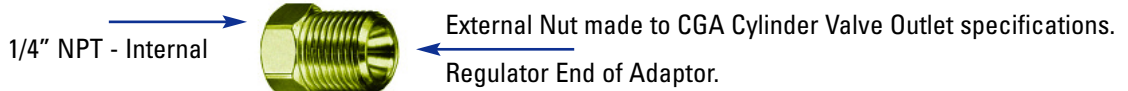

Ratermann Part No.	Std. Pkg.	Description	PS.I.G.
CGA-200F14	10	<b>CGA-200</b> "MC" Tank Acetylene Cylinder Valve Outlet .625" - 20 NGO-RH-EXT to 1/4" NPT - F Regulator End of Adaptor No. A792	250 PS.I.G.
CGA-300F14	10	<b>CGA-300</b> Commercial Acetylene Cylinder Valve Outlet .825" - 14 NGO-RH-EXT to 1/4" NPT - F Regulator End of Adaptor No. A830	250 PS.I.G.
CGA-90D300F14	10	<b>CGA-300</b> 90° Commercial Acetylene Cylinder Valve Outlet .825" - 14 NGO-RH-EXT to 1/4" NPT - F Regulator End of Adaptor No. A832	250 PS.I.G.
CGA-320F14	10	<b>CGA-320</b> Carbon Dioxide Cylinder Valve Outlet .825" - 14 NGO-RH-EXT to 1/4" NPT - F Regulator End of Adaptor No. A854	3000 PS.I.G.
CGA-320F14CH	10	<b>CGA-320</b> Carbon Dioxide Cylinder Valve Outlet .825" - 14 NGO-RH-EXT to 1/4" NPT - F Regulator End of Adaptor No. A854	3000 PS.I.G.
CGA-326F14	10	<b>CGA-326</b> Nitrous Oxide Cylinder Valve Outlet .825" - 14 NGO-RH-EXT to 1/4" NPT - F Regulator End of Adaptor No. A811	3000 PS.I.G.
CGA-326F14CH	10	<b>CGA-326</b> Nitrous Oxide Cylinder Valve Outlet .825" - 14 NGO-RH-EXT to 1/4" NPT - F Regulator End of Adaptor No. A811	3000 PS.I.G.
CGA-330F14	10	<b>CGA-330</b> Various Non-Corrosive Gases Cylinder Valve Outlet .825" - 14 NGO-LH-EXT to 1/4" NPT - F	3000 PS.I.G.
CGA-346F14	10	<b>CGA-346</b> Air Cylinder Valve Outlet .825" - 14 NGO-RH-EXT to 1/4" NPT - F Regulator End of Adaptor No. A866	3000 PS.I.G.
CGA-346F14CH	10	<b>CGA-346</b> Air Cylinder Valve Outlet .825" - 14 NGO-RH-EXT to 1/4" NPT - F Regulator End of Adaptor No. A661	3000 PS.I.G.
CGA-347F14	10	<b>CGA-347</b> Air Cylinder Valve Outlet .825" - 14 NGO-RH-EXT to 1/4" NPT Regulator End of Adaptor No. A866	5500 PS.I.G.
CGA-350F14	10	<b>CGA-350</b> Hydrogen or Methane Cylinder Valve Outlet .825" - 14 NGO-LH-EXT to 1/4" NPT - F Regulator End of Adaptor No. A874	3000 PS.I.G.
CGA-350F14CH	10	<b>CGA-350</b> Hydrogen or Methane Cylinder Valve Outlet .825" - 14 NGO-LH-EXT to 1/4" NPT - F Regulator End of Adaptor No. A874	3000 PS.I.G.

CH=Chrome Plated

# BRASS & BRASS CHROME PLATED ADAPTOR NUTS

## CGA VALVE OUTLET ADAPTOR NUTS TO FEMALE NPT THREAD (continued)

Ratermann Part No.	Std. Pkg.	Description	
CGA-410F14	10	<b>CGA-410</b> Canadian Acetylene Cylinder Valve Outlet .850" - 14 NGO-LH-EXT to 1/4" NPT - F Regulator End of Adaptor No. A836	250 P.S.I.G.
CGA-90D520F14	10	<b>CGA-520</b> 90° "B" Tank Acetylene Cylinder Valve Outlet .895" - 18 NGO-RH-EXT to 7/16" - 20 - F Regulator End of Adaptor No. A783	250 P.S.I.G.
CGA-520F14	10	<b>CGA-520</b> "B" Tank Acetylene Cylinder Valve Outlet .895" - 18 NGO-RH-EXT to 7/16" - 20 - F Regulator End of Adaptor No. A784	250 P.S.I.G.
CGA-520F14CH	10	<b>CGA-520</b> "B" Tank Acetylene Cylinder Valve Outlet .895" - 18 NGO-RH-EXT to 1/4" NPT - F Regulator End of Adaptor No. A840	250 P.S.I.G.
CGA-540F14	10	<b>CGA-540</b> Oxygen Cylinder Valve Outlet .903" - 14 NGO-RH-EXT to 1/4" NPT - F Regulator End of Adaptor No. A876	3000 P.S.I.G.
CGA-540F14CH	10	<b>CGA-540</b> Oxygen Cylinder Valve Outlet .903" - 14 NGO-RH-EXT to 1/4" NPT - F Regulator End of Adaptor No. A876	3000 P.S.I.G.
CGA-660F14	10	<b>CGA-660</b> Refrigerant Gases Cylinder Valve Outlet 1.030" - 14 NGO-RH-EXT to 1/4" NPT - F Regulator End of Adaptor No. A880	3000 P.S.I.G.
CGA-660F14CH	10	<b>CGA-660</b> Refrigerant Gases Cylinder Valve Outlet 1.030" - 14 NGO-RH-EXT to 1/4" NPT - F Regulator End of Adaptor No. A880	3000 P.S.I.G.
CGA-555F14	10	<b>CGA-555</b> Propane (Liquid Withdrawal) Cylinder Valve Outlet .903" - 14 NGO-LH-EXT to 1/4" NPT - F Regulator End of Adaptor No. A885	3000 P.S.I.G.
CGA-555F14CH	10	<b>CGA-555</b> Propane (Liquid Withdrawal) Cylinder Valve Outlet .903" - 14 NGO-LH-EXT to 1/4" NPT - F Regulator End of Adaptor No. A885	3000 P.S.I.G.
CGA-347F14	10	<b>CGA-347</b> Air Cylinder Valve Outlet .825 - 14 NGO RH Ext. to 1/4 NPT F Regulator End of Adaptor No. A661	5500 P.S.I.G.
CGA-577F14	10	<b>CGA-577</b> Oxygen Cylinder Valve Outlet .960 - 14 NGO RH Ext. to 1/4 NPT F Regulator End of Adaptor No. A563	4000 P.S.I.G.
CGA-677F14	10	<b>CGA-677</b> Inert Gas Cylinder Valve Outlet 1.030 - 14 NGO LH Ext. to 1/4 NPT F Regulator End of Adaptor No. A671	7500 P.S.I.G.
CGA-701F14	10	<b>CGA-701</b> Oxygen Cylinder Valve Outlet 1.103 - 18 NGO RH Ext. to 1/4 NPT F Regulator End of Adaptor No. A753	

CH=Chrome Plated

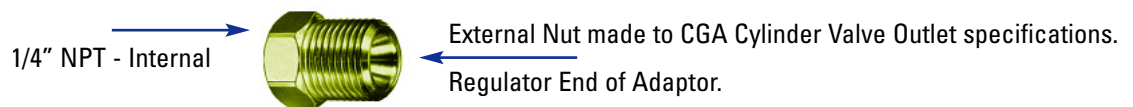

Ratermann Part No.	Std. Pkg.	Description	
CGA-296F14	10	<b>CGA-296</b> Ind. Oxygen mixtures Cylinder Valve Outlet .803" UNS-2B-RH-INT to 1/4" NPT - F Regulator End of Adaptor No. A853	3000 P.S.I.G.
CGA-296F14CH	10	<b>CGA-296</b> Ind. Oxygen mixtures Cylinder Valve Outlet .803" UNS-2B-RH-INT to 1/4" NPT - F Regulator End of Adaptor No. A853	3000 P.S.I.G.
CGA-510F14	10	<b>CGA-510</b> Acetylene or Propane Cylinder Valve Outlet .885" - 14 NGO-LH-INT to 1/4" NPT - F Regulator End of Adaptor No. A800	Acetylene 250 P.S.I.G. Propane 500 P.S.I.G.
CGA-510F14CH	10	<b>CGA-510</b> Acetylene or Propane Cylinder Valve Outlet .885" - 14 NGO-LH-INT to 1/4" NPT - F Regulator End of Adaptor No. A800	Acetylene 250 P.S.I.G. Propane 500 P.S.I.G.
CGA-90D510F14	10	<b>CGA-510</b> 90° P.O.L. Acetylene Cylinder Valve Outlet .885" - 14 NGO-LH-EXT to 1/4" NPT - F Regulator End of Adaptor No. A802	250 P.S.I.G.
CGA-500F14	10	<b>CGA-500</b> Medical Mixtures Cylinder Valve Outlet .885" - 14 NGO-RH-INT to 1/4" NPT - F Regulator End of Adaptor No. A807	3000 P.S.I.G.
CGA-500F14CH	10	<b>CGA-500</b> Medical Mixtures Cylinder Valve Outlet .885" - 14 NGO-RH-INT to 1/4" NPT - F Regulator End of Adaptor No. A807	3000 P.S.I.G.
CGA-580F14	10	<b>CGA-580</b> Argon, Nitrogen or Helium Cylinder Valve Outlet .965" - 14 NGO-RH-INT to 1/4" NPT - F Regulator End of Adaptor No. A862	3000 P.S.I.G.
CGA-580F14CH	10	<b>CGA-580</b> Argon, Nitrogen or Helium Cylinder Valve Outlet .965" - 14 NGO-RH-INT to 1/4" NPT - F Regulator End of Adaptor No. A862	3000 P.S.I.G.
CGA-590F14	10	<b>CGA-590</b> Industrial Air Cylinder Valve Outlet .965" - 14 NGO-LH-EXT to 1/4" NPT - F Regulator End of Adaptor No. A954	3000 P.S.I.G.
CGA-680F14	10	<b>CGA-680</b> Inert Gas Cylinder Valve Outlet 1.045" - 14 NGO-RH-INT to 1/4" NPT - F Regulator End of Adaptor No. A683	5500 P.S.I.G.
CGA-702F14	10	<b>CGA-702</b> Air Cylinder Valve Outlet 1.125" - 14 NGO-RH-INT to 1/4" NPT - F Regulator End of Adaptor No. A763	7500 P.S.I.G.

CH=Chrome Plated

# BRASS CGA CYLINDER TO REGULATOR ADAPTORS

## CGA200-CGA300 250 P.S.I.G.



Part No.	Western Equivalent Part No.	Std. Pkg.
A-775	322	1

## CGA200-CGA510 250 P.S.I.G.



Part No.	Western Equivalent Part No.	Std. Pkg.
A-780	321	1

## CGA200-CGA510 250 P.S.I.G.



Part No.	Western Equivalent Part No.	Std. Pkg.
A-781	324	1

## CGA200-CGA520 250 P.S.I.G.



Part No.	Western Equivalent Part No.	Std. Pkg.
A-783	305	1

## CGA200-CGA520 250 P.S.I.G.



Part No.	Western Equivalent Part No.	Std. Pkg.
A-784	314	1

## CGA280-CGA540 3000 P.S.I.G.



Part No.	Western Equivalent Part No.	Std. Pkg.
A-789	831	1

## CGA300-CGA200 250 P.S.I.G.



Part No.	Western Equivalent Part No.	Std. Pkg.
A-792	304	1

## CGA300-CGA510 250 P.S.I.G.



Part No.	Western Equivalent Part No.	Std. Pkg.
A-800	16	1

## CGA300-CGA510 250 P.S.I.G.



Part No.	Western Equivalent Part No.	Std. Pkg.
A-801	61	1

## CGA300-CGA510 250 P.S.I.G.

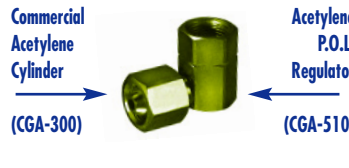

Part No.	Western Equivalent Part No.	Std. Pkg.
A-802	1690	1

## CGA300-CGA520 250 P.S.I.G.

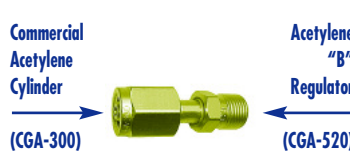

Part No.	Western Equivalent Part No.	Std. Pkg.
A-804	316	1

## CGA320-CGA580 3000 P.S.I.G.



Part No.	Western Equivalent Part No.	Std. Pkg.
A-809	806	1

## CGA346-CGA540 3000 P.S.I.G.



Part No.	Western Equivalent Part No.	Std. Pkg.
A-930	827	1

## CGA346-CGA580 3000 P.S.I.G.



Part No.	Western Equivalent Part No.	Std. Pkg.
A-935	828	1

## CGA346-CGA590 3000 P.S.I.G.



Part No.	Western Equivalent Part No.	Std. Pkg.
A-937	843	1

## CGA350-CGA580 3000 P.S.I.G.



Part No.	Western Equivalent Part No.	Std. Pkg.
A-820	808	1

## CGA415-CGA510 250 P.S.I.G.



Part No.	Western Equivalent Part No.	Std. Pkg.
A-827	—	1

## CGA500-CGA580 3000 P.S.I.G.



Part No.	Western Equivalent Part No.	Std. Pkg.
A-912	873	1

## CGA510 - CGA200 250 P.S.I.G.



Part No.	Western Equivalent Part No.	Std. Pkg.
A-828	320	1

## CGA510 - CGA300 500 P.S.I.G.



Part No.	Western Equivalent Part No.	Std. Pkg.
A-830	15	1

**CYLINDER ADAPTORS CAN BE USED AS A TEMPORARY CONNECTION UNTIL A REGULATOR WITH THE PROPER INLET CONNECTION CAN BE INSTALLED**  
**CGA V-1, PAR. 5.1, "ADAPTORS" 5 Adaptors 5.1**

In the standardization of compressed gas cylinder valve outlet connections, more than one outlet is specified for some gases. To provide interchangeability of users' equipment FOR THE SAME GAS, adaptors may be required. CGA recognizes adaptors designed to connect a cylinder valve outlet to a regulator, charging connection or other mating part having a different connection FOR THE SAME GAS. Adaptors are permitted for standard connections between standard, alternate standard, or limited standard connections FOR THE SAME GAS, unless the use of such adaptors could result in undesirable connections. For example, EVEN FOR THE SAME GAS, ADAPTORS MUST NOT BE USED WHICH CONNECT A HIGH PRESSURE SOURCE TO EQUIPMENT RATED AT A LOWER PRESSURE. Other adaptors may be used by suppliers of gases or related equipment at their facilities.

# BRASS CGA CYLINDER TO REGULATOR ADAPTORS

## CGA300-CGA510 500 P.S.I.G.

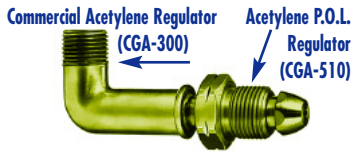

Part No.	Western Equivalent Part No.	Std. Pkg.
A-832	1590	1

## CGA510-CGA410 250 P.S.I.G.



Part No.	Western Equivalent Part No.	Std. Pkg.
A-836	1516	1

## CGA510-CGA300 500 P.S.I.G.



Part No.	Western Equivalent Part No.	Std. Pkg.
A-831	51	1

## CGA510-CGA510 250 P.S.I.G.



Part No.	Western Equivalent Part No.	Std. Pkg.
A-838	820	1

## CGA510-CGA520 250 P.S.I.G.



Part No.	Western Equivalent Part No.	Std. Pkg.
A-840	315	1

## CGA510-CGA555 250 P.S.I.G.



Part No.	Western Equivalent Part No.	Std. Pkg.
A-841	—	1

## CGA520-CGA200 250 P.S.I.G.



Part No.	Western Equivalent Part No.	Std. Pkg.
A-842	306	1

## CGA520-CGA300 250 P.S.I.G.



Part No.	Western Equivalent Part No.	Std. Pkg.
A-844	319	1

## CGA520-CGA510 250 P.S.I.G.

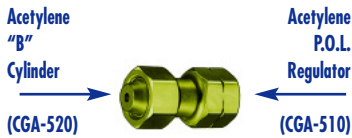

Part No.	Western Equivalent Part No.	Std. Pkg.
A-848	317	1

## CGA520-CGA510 250 P.S.I.G.



Part No.	Western Equivalent Part No.	Std. Pkg.
A-850	318	1

## CGA540-CGA296 3000 P.S.I.G.



Part No.	Western Equivalent Part No.	Std. Pkg.
A-853	—	1

## CGA540-CGA580 3000 P.S.I.G.



Part No.	Western Equivalent Part No.	Std. Pkg.
A-862	416	1

## CGA555-CGA580 3000 P.S.I.G.



Part No.	Western Equivalent Part No.	Std. Pkg.
A-952	809	1

## CGA580-CGA320 3000 P.S.I.G.



Part No.	Western Equivalent Part No.	Std. Pkg.
A-870	810	1

## CGA580-CGA346 3000 P.S.I.G.



Part No.	Western Equivalent Part No.	Std. Pkg.
A-882	830	1

## CGA580-CGA540 3000 P.S.I.G.



Part No.	Western Equivalent Part No.	Std. Pkg.
A-876	415	1

## CGA580-CGA555 3000 P.S.I.G.



Part No.	Western Equivalent Part No.	Std. Pkg.
A-885	812	1

## CGA580-CGA590 250 P.S.I.G.



Part No.	Western Equivalent Part No.	Std. Pkg.
A-879	813	1

## CGA590 - CGA346 3000 P.S.I.G.



Part No.	Western Equivalent Part No.	Std. Pkg.
A-894	858	1

## CGA590 - CGA580 3000 P.S.I.G.

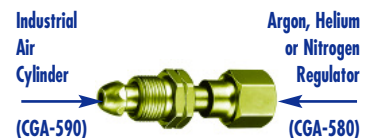

Part No.	Western Equivalent Part No.	Std. Pkg.
A-892	815	1

**CYLINDER ADAPTORS CAN BE USED AS A TEMPORARY CONNECTION UNTIL A REGULATOR WITH THE PROPER INLET CONNECTION CAN BE INSTALLED**  
**CGA V-1, PAR. 5.1, "ADAPTORS" 5 Adaptors 5.1**

In the standardization of compressed gas cylinder valve outlet connections, more than one outlet is specified for some gases. To provide interchangeability of users' equipment FOR THE SAME GAS, adaptors may be required. CGA recognizes adaptors designed to connect a cylinder valve outlet to a regulator, charging connection or other mating part having a different connection FOR THE SAME GAS. Adaptors are permitted for standard connections between standard, alternate standard, or limited standard connections FOR THE SAME GAS, unless the use of such adaptors could result in undesirable connections. For example, EVEN FOR THE SAME GAS, ADAPTORS MUST NOT BE USED WHICH CONNECT A HIGH PRESSURE SOURCE TO EQUIPMENT RATED AT A LOWER PRESSURE. Other adaptors may be used by suppliers of gases or related equipment at their facilities.

# BRASS MANIFOLD PIPE AND PIPE FITTINGS

**PIPE NIPPLES, THREADED ENDS 3000 P.S.I.G.**

**PIPE LENGTHS, PLAIN ENDS 3000 P.S.I.G.**

*Cleaned For Oxygen Service  
Suitable For Acetylene  
Machined From CDA 360 Brass*



**GMF-3214**

Part No.	Western Equivalent Part No.	Thread Size	Length
GMF-3211	WHF-3-1	1/2"-14 NPT	1-1/2"
GMF-3212	WHF-3-2	1/2"-14 NPT	2"
GMF-3213	WHF-3-3	1/2"-14 NPT	4"
GMF-3214	WHF-3-19	1/2"-14 NPT	6"
GMF-3215	WHF-3-5	1/2"-14 NPT	9-3/4"
GMF-3216	WHF-3-7	1/2"-14 NPT	12-3/4"

**CHECK VALVE OUTLET ADAPTORS**



**A-603CV**



**A-643CV**

Part No.	Western Equivalent Part No.	Oper. Pres.	Description
A-633CV	WMS-1-53	3000	CGA-326 to 1/2"-14 NPT w/Check Valve
A-643CV	WMS-1-62	3000	CGA-346 to 1/2"-14 NPT w/Check Valve
A-593CV	WMS-1-59	3000	CGA-540 to 1/2"-14 NPT w/Check Valve
A-603CV	WMS-1-54	3000	CGA-580 to 1/2"-14 NPT w/Check Valve
A-543CV	WMS-1-65	3000	CGA-320 to 1/2"-14NPT w/Check Valve

**UNION NUTS 3000 P.S.I.G.**

**GMF-3311**



Part No.	Western Equivalent Part No.	Thread
GMF-3311	WHF-3-29	1" - 11 - 1/2 NPS RH-Female
GMF-3312	WHF-3-30	1" - 11 - 1/2 NPS LH-Female

**UNION BUSHINGS WITH FILTER 3000 P.S.I.G.**

**GMF-3333**

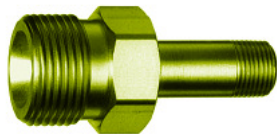

Part No.	Western Equivalent Part No.	Thread	Pipe Thread	Length
GMF-3333	1WMS-1-44	1"-11½ NPS RH	3/8"-18 NPT	3.125"
GMF-3334	1WMS-1-44	1"-11-1/2 NPS RH	1/2"-14 NPT	2.187"
GMF-3337	1WMS-1-44	1"-11-1/2 NPS LH	3/8"-18 NPT	3.125"
GMF-3338	1WMS-1-44	1"-11-1/2 NPS LH	1/2"-14 NPT	2.187"
GMF-3341	—	Replacement Filter		
GMF-3342	—	Replacement Snap-Ring		

*Cleaned For Oxygen Service  
Suitable For Acetylene  
Machined From CDA 360 Brass  
Special Lengths Available Upon Request*



**GMF-3224**

Part No.	Western Equivalent Part No.	Thread Size	Length
GMF-3222	WHF-3-23	1/2" Nom.	2"
GMF-3223	WHF-3-4	1/2" Nom.	4"
GMF-3224	WHF-3-2	1/2" Nom.	6"
GMF-3225	WHF-3-6	1/2" Nom.	9-3/4"
GMF-3226	WHF-3-8	1/2" Nom.	12-3/4"

**PIPE LENGTHS, PLAIN ENDS 3000 P.S.I.G.**

***NOT CLEANED** For Oxygen Service  
Suitable For Acetylene  
Made From CDA 360 Brass*

Part No.	Western Equivalent Part No.	Thread Size	Length
GMF-3236	WHF-3-120	1/2" Nom.	6 Ft. Random
GMF-3237	WHF-3-17	1/2" Nom.	12 Ft. Random



**UNION NIPPLES 3000 P.S.I.G.**

**GMF-3326**



Part No.	Western Equivalent Part No.	Thread Size	Length
GMF-3321	WHF-3-36	3/8" - 18 NPT	2.40"
GMF-3326	WHF-3-35	1/2" - 14 NPT	2.94"

**UNION BUSHINGS WITHOUT FILTER 3000 P.S.I.G.**

**GMF-3332**



Part No.	Western Equivalent Part No.	Thread	Pipe Thread	Length
GMF-3331	WHF-3-37	1"-11½ NPS RH	3/8"-18 NPT	3.125"
GMF-3332	WHF-3-31	1"-11½ NPS RH	1/2"-14 NPT	2.187"
GMF-3335	WHF-3-38	1"-11½ NPS LH	3/8"-18 NPT	3.125"
GMF-3336	WHF-3-32	1"-11½ NPS LH	1/2"-14 NPT	2.187"

# GAS MANIFOLD ELBOWS, TEES AND CROSSES

## BRASS MANIFOLD ELBOWS, TEES AND CROSSES

FITTINGS ARE MACHINED FROM CDA-360 BRASS, STRESS RELIEVED AND CLEANED FOR OXYGEN SERVICE

### PIPE ELBOWS

3000 P.S.I.G.

### PIPE CROSSES

3000 P.S.I.G.

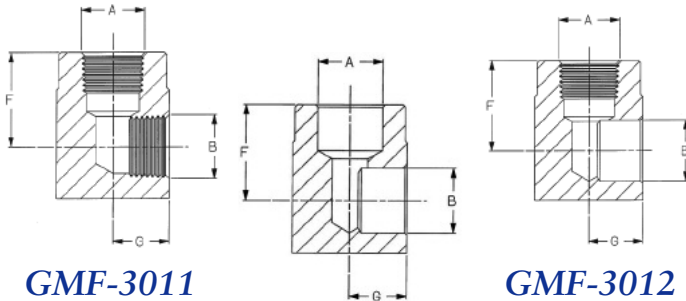

GMF-3011

GMF-3013

GMF-3012

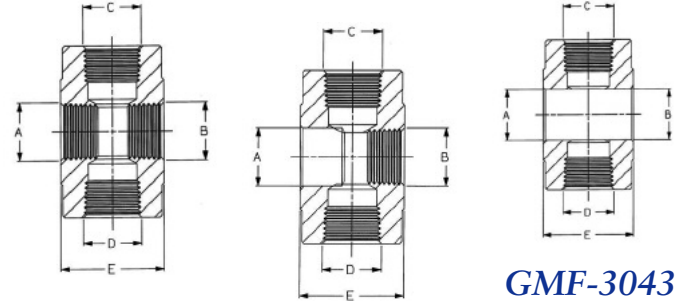

GMF-3041

GMF-3042

GMF-3043

Part No.	Western Equivalent Part No.	Ref. A	Ref. B	Ref. F	Ref. G
GMF-3011	WHF-4-8	1/2"-14 NPT	1/2"-14 NPT	1-5/16"	3/4"
GMF-3012	WHF-4-15	1/2"-14 NPT	.843"-.847"	1-5/16"	3/4"
GMF-3013	WHF-4-2	.843"-.847"	.843"-.847"	1-5/16"	3/4"

Part No.	Western Equivalent Part No.	Ref. A	Ref. B	Ref. C&D	Ref. G
GMF-3041	WHF-4-9	1/2"-14 NPT	1/2"-14 NPT	1/2"-12 NPT	1-1/2"
GMF-3042	WHF-4-23	.843"-.847"	1/2"-14 NPT	1/2"-12 NPT	1-1/2"
GMF-3013	WHF-4-16	.843"-.847"	Slip Thru	1/2"-12 NPT	1-1/2"

### PIPE TEES

3000 P.S.I.G.

### PIPE TEES

3000 P.S.I.G.

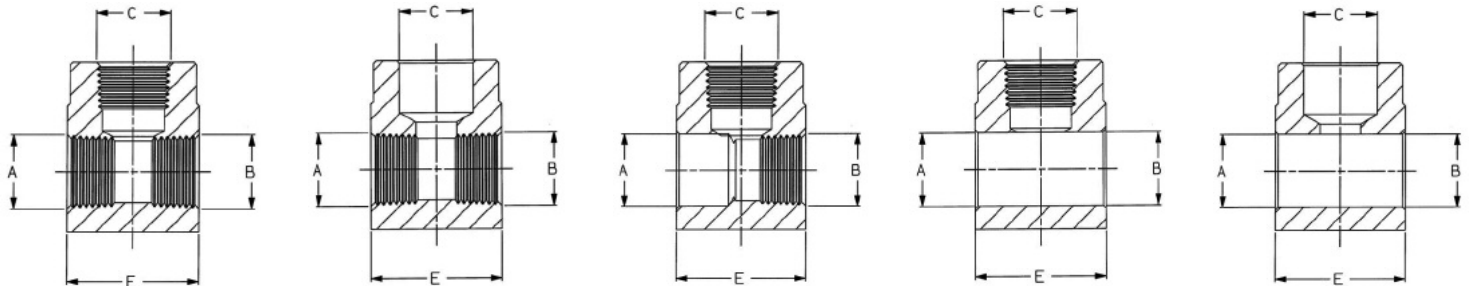

GMF-3021

GMF-3022

GMF-3023

GMF-3033

GMF-3034

Part No.	Western Equivalent Part No.	Ref. A	Ref. B	Ref. C	Ref. E
GMF-3021	WHF-4-7	1/2"-14 NPT	1/2"-14 NPT	1/2"-14 NPT	1-1/2"
GMF-3022	WHF-4-13	1/2"-14 NPT	1/2"-14 NPT	.843"-.847"	1-1/2"
GMF-3023	WHF-4-21	.843"-.847"	1/2"-14 NPT	1/2"-14 NPT	1-1/2"

Part No.	Western Equivalent Part No.	Ref. A	Ref. B	Ref. C	Ref. E
GMF-3033	WHF-4-14	.843"-.847"	Slip Thru	1/2"-14 NPT	1-1/2"
GMF-3034	WHF-4-1	.843"-.847"	Slip Thru	.843"-.847"	1-1/2"

### ZERO CLEARANCE FITTINGS

1000 P.S.I.G.

### ZERO CLEARANCE FITTINGS

3000 P.S.I.G.

Flange Part No.	Western Equivalent Part No.	Thread
FL-ZC-04A	—	1/4"-18 NPT-M
FL-ZC-06A	—	3/8"-18 NPT-M
FL-ZC-08A	—	1/2"-14NPT-M
FL-ZC-12A	—	3/4"-14 NPT-M

Flange Part No.	Western Equivalent Part No.	Thread
N-ZC-04A	—	1/4"-18 NPT-F
N-ZC-06A	—	3/8"-18 NPT-F
N-ZC-08A	—	1/2"-14NPT-F
N-ZC-12A	—	3/4"-14 NPT-F

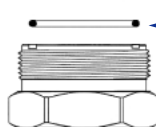
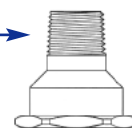

Nut Part No.	Western Equivalent Part No.
N-ZC-001	— Nut, for all zero clearance

Zero clearance for easy removal of piped components  
All thread sizes can be mixed & matched  
Largest possible through holes for maximum flow

Nut Part No.	Western Equivalent Part No.
*OR-024B7	— Replacement O-Ring

\*Boss includes O-Ring